

9-12-2014

Facility-Specific Radiation Exposure Risks and Their Implications for Radiation Workers at Department of Energy Laboratories

Adam Davis

Follow this and additional works at: https://digitalrepository.unm.edu/ne_etds

Recommended Citation

Davis, Adam. "Facility-Specific Radiation Exposure Risks and Their Implications for Radiation Workers at Department of Energy Laboratories." (2014). https://digitalrepository.unm.edu/ne_etds/9

This Dissertation is brought to you for free and open access by the Engineering ETDs at UNM Digital Repository. It has been accepted for inclusion in Nuclear Engineering ETDs by an authorized administrator of UNM Digital Repository. For more information, please contact disc@unm.edu.

Adam Christopher Davis

Candidate

Chemical and Nuclear Engineering

Department

This dissertation is approved, and it is acceptable in quality and form for publication:

Approved by the Dissertation Committee:

Cassiano R.E. de Oliveira , Chairperson

Kenya Moore de Almeida Dias da Cunha

Donald J. Dudziak

Drew E. Kornreich

Adam A. Hecht

Timothy J. Ross

FACILITY-SPECIFIC RADIATION EXPOSURE RISKS AND
THEIR IMPLICATIONS FOR RADIATION WORKERS AT
DEPARTMENT OF ENERGY LABORATORIES

BY

ADAM CHRISTOPHER DAVIS

B.S. PHYSICS, UNIVERSITY OF NORTH CAROLINA-
GREENSBORO
M.S. NUCLEAR ENGINEERING, NORTH CAROLINA STATE
UNIVERSITY

DISSERTATION

Submitted in Partial Fulfillment of the
Requirements for the Degree of

Doctor of Philosophy
in
Engineering

The University of New Mexico
Albuquerque, New Mexico

July, 2014

Dedication

**This dissertation is dedicated to my beautiful wife Melissa and our baby girl,
Sophie.**

Acknowledgements

I am extremely thankful to have had Professor Donald Dudziak and Dr. Drew Kornreich as mentors and friends over the last eight years; this work would simply not exist without the two of you. I continue to learn so much from each of you.

I would like to thank my parents and my brother, who have always seemed to be able to see the light at the end of this particular tunnel, even when I was sure it was just a cave. Their love, support and positivity has made me who I am, and I am very grateful for them.

Thank you to Drs. Cassiano de Oliveira and Kenya M. de Almeida Dias da Cunha for giving me an opportunity to study in the Chemical and Nuclear Engineering department at UNM and for largely restoring my faith in academic humanity.

Finally, to my best friend, confidant, accomplice and wife, Melissa I say thank you so much for your patience, love and support. I am so lucky to be married to you.

**FACILITY-SPECIFIC RADIATION EXPOSURE RISKS AND THEIR
IMPLICATIONS FOR RADIATION WORKERS AT DEPARTMENT OF
ENERGY LABORATORIES**

ADAM CHRISTOPHER DAVIS

B.S., Physics, University of North Carolina – Greensboro 2005

M.S., Nuclear Engineering, North Carolina State University 2007

Ph.D., Engineering, UNM, 2014

Abstract

This research develops a new framework for evaluating the occupational risks of exposure to hazardous substances in any setting where As Low As Reasonably Achievable (ALARA) practices are mandated or used. The evaluation is performed by developing a hypothesis-test-based procedure for evaluating the homogeneity of various epidemiological cohorts, and thus the appropriateness of the application of aggregate data-pooling techniques to those cohorts. A statistical methodology is then developed as an alternative to aggregate pooling for situations in which individual cohorts show heterogeneity between them and are thus unsuitable for pooled analysis.

These methods are then applied to estimate the all-cancer mortality risks incurred by workers at four Department-of-Energy nuclear weapons laboratories. Both linear, no-threshold and dose-bin averaged risks are calculated and it is further shown that aggregate analysis tends to overestimate the risks with respect to those calculated by the methods developed in this work.

The risk estimates developed in Chapter 2 are, in Chapter 3, applied to assess the risks to workers engaged in americium recovery operations at Los Alamos National Laboratory. The work described in Chapter 3 develops a full radiological protection assessment for the new americium recovery project, including development of exposure cases, creation and modification of MCNP5 models, development of a time-and-motion study, and the final synthesis of all data. This work also develops a new risk-based method of determining whether administrative controls, such as staffing increases, are ALARA-optimized. The EPA's estimate of the value of statistical life is applied to these risk estimates to determine a monetary value for risk. The rate of change of this "risk value" (marginal risk) is then compared with the rate of change of workers' compensations as additional workers are added to the project to reduce the dose (and therefore, presumably, risk) to each individual.

Table of Contents

Chapter 1. Historical Analysis	1
1.1 Introduction.....	1
1.2 Background.....	2
1.2.1 Quantities	2
1.2.2 History of Radiation Regulations.....	6
1.2.3 Review of Dose-Response Models	21
1.2.4 Design Goals and the Evolution of Occupational Risk.....	36
1.2.5 Los Alamos Dose Records and Historical Events.....	37
1.3 Chapter Conclusion.....	45
Chapter 2. Radiogenic Cancer Risk: Methodology and Estimation	48
2.1 Introduction.....	48
2.2 Background.....	50
2.3 Methods	53
2.3.1 Risk Estimates.....	53
2.3.2 Assessing Effect-Size Homogeneity: Fixed and Random Effects Models	58
2.3.3 Data Sets	62
2.4 Results.....	72
2.4.1 Evaluation of Facility Homogeneity	72
2.4.2 Regression Analysis - Linear, No Threshold Model.....	74
2.4.3 Dose Bin Averaging.....	76
2.5 Chapter Conclusions	79
Chapter 3. Application of Risk Estimates to ALARA assessment of the Americium Recovery Project	82
3.1 Introduction.....	82
3.2 Background.....	82
3.3 Methods	87
3.3.1 Radiation Transport Calculations.....	87
3.3.2 Response Functions	98
3.3.3 Time-Motion Study.....	100
3.3.4 Marginal Risk-Benefit Analysis.....	108
3.4 Results.....	114
3.4.1 Whole-body Results.....	115
3.4.2 Extremity Dose	117

3.4.3 Estimating the Minimum Number of Workers to Maintain Risks at Acceptable Levels	120
3.5 Chapter Conclusions	129
3.5.1 Summary of Results	130
Chapter 4. Final Summary and Conclusion	132
4.1 Introduction.....	132
4.2 Accomplishments.....	132
4.2.1 Epidemiological Accomplishments	132
4.2.2 Accomplishments related to the Americium Recovery Project Analysis	133
4.3 Results.....	133
4.3.1 Epidemiological Results	133
4.3.2 Results of the Americium Project Risk Analysis.....	134
4.4 Future Work.....	136
4.5 Conclusion	137
Bibliography	138

List of Figures

Figure 1. Schematic representation of several pertinent (notional) dose response models: linear, no threshold, linear threshold, hormesis, sublinear, and supralinear. The box to the left of the abscissa shows the “zero-equivalency point” (ZEP) which is the point at which there are no radiogenic effects. The sublinear and hormesis models follow the linear model above certain doses in this plot, though this is not necessarily representative of reality.	28
Figure 2. Estimated risks (relative to an unexposed individual) of solid cancer in atomic bomb survivors exposed to low radiation doses [40]. Data points are placed at the mean of each dose category. The solid curve represents a weighed moving average of the points shown (dotted curves ± 1 SE) and the dashed straight line is a linear risk estimate computed from all the data in the dose range of 0-2 Sv. Age-specific cancer rates from 1958-1994 are used, averaged over follow-up and gender [38].	31
Figure 3. Fraction of exposed Los Alamos workers exposed to ionizing radiation at doses exceeding 100 and 500 mrem in a year.	37
Figure 4. Routine (Non-accidental) average doses by year at Los Alamos National Laboratory. The white boxes at the top show the Laboratory directors’ names. The colored boxes show the president color-coded by political affiliation (red for republican, blue for democrat).	39
Figure 5. Stair plot of the relative risks for the Los Alamos National Laboratory data set stratified into eight dose bins.	65
Figure 6. Frequency distribution of doses in highest dose bin for Los Alamos data set. .	66
Figure 7. Histogram of the relative risks for the Hanford site data set stratified into eight dose bins.	67
Figure 8. Frequency distribution for doses in the Hanford data set.	68
Figure 9. Histogram of the relative risks for the Rocky Flats data set stratified into eight dose bins.	69
Figure 10. Histogram of the frequency distribution of doses in the highest bin for the Rocky Flats data set.	70
Figure 11. Histogram of the relative risks for the Oak ridge National Laboratory data set stratified into eight dose bins.	71
Figure 12. Histogram of the frequency distribution of doses in the highest dose bin in the Oak Ridge National Laboratory Data set.	72
Figure 13. Comparison of linear, no-threshold estimates of risk. The summary estimate developed by this work nearly overlaps with the BEIR VII estimate which takes a DDREF of 2.	74
Figure 14. Relative risks from Los Alamos National Laboratory, Oak Ridge National Laboratory, the Rocky Flats Plant and the Hanford Site combined using the method developed in this work. Error bars represent 95% confidence intervals.	76
Figure 15. Relative risks calculated from pooled (Aggregated) data from all four studies.	78
Figure 16. Histogram showing frequency of doses in the highest dose bin for the pooled data set. Abscissa labels are at bin midpoints. Lowest dose bin contains 3,587 doses that are cut off for ease of display.	79
Figure 17. Photon spectrum for Americium-241 source material.	88
Figure 18. Neutron spectrum for americium-241 oxide and oxalate.	88

Figure 19. MCNP Visual Editor model of a glovebox used for Am-241 recovery.	91
Figure 20. Three-dimensional model of americium recovery Glovebox 2.....	93
Figure 21. Solid/Wireframe model of Glovebox 2.	93
Figure 22. Porcelain filter boat (left), MCNP5 solid model of porcelain filter boat (center), and MCNP solid/wireframe model of porcelain filter boat to illustrate the source location (right).	94
Figure 23. Model image of Glovebox 4 (calcination glovebox). Through the transparent side panel the crucible is visible along with the inner shipping container in the pig/jig. .	95
Figure 24. Engineering drawing of innermost shipping container (far left) for americium oxide [115] shown along with its solid (center) and wireframe (far right) MCNP5 models.	96
Figure 25. Engineering drawing of the pig/jig (far left) [116] followed by MCNP5 models in various stages of wireframe transparency to show details.....	97
Figure 26. Engineering drawing of middle shipping container (far left) shown along with solid MCNP5 model of middle shipping container (center) and wireframe/solid model of the nested configuration of middle and inner containers (far right). During shipping, the inner container will be nested inside the middle container [117].	97
Figure 27. HP(10,0*) personal dose equivalent response function for photons from ICRP 74.....	99
Figure 28. Hp(10) personal dose equivalent response function for neutrons.	100
Figure 29. Example flow sheet for the development of a time-motion study for operations currently in practice.	102
Figure 30. Example flow sheet for the development of a time-motion study for proposed operations.....	103
Figure 31. Whole Body Dose per operation for a single batch (left) Worker Time (in hours) per operation for a single batch (right).	117
Figure 32. Marginal cost and benefit curves for 1-rem watch level. The benefit is defined as the difference in the ALARA-reasonable expenditure between 1 and n employees. The marginal cost is the change in the amount spent to compensate each employee.....	123
Figure 33. Marginal cost and benefit curves for 800-mrem watch level. The benefit is defined as the difference in the ALARA-reasonable expenditure between 1 and n employees. The marginal cost is the change in the amount spent to compensate each employee.	123
Figure 34. Marginal cost and benefit curves for 500-mrem watch level. The benefit is defined as the difference in the ALARA-reasonable expenditure between 1 and n	124
Figure 35. Comparison of marginal risk values for both LNT and bin-averaged estimates of risk with marginal benefit values. Staffing levels are incremented by 0.1 employees.	125
Figure 36. Comparison of Marginal Risk Value (LNT) with marginal ALARA value at a watch level of 1 rem/year. Staff levels are incremented by 0.1 workers. The discontinuity is due to the piece-wise definition of the ALARA value; the break occurs where the first derivative does not exist.....	127
Figure 37. Comparison of Marginal Risk Value (LNT) with marginal ALARA value at a watch level of 0.8 rem/year. Staff levels are incremented by 0.1 workers. The discontinuity is due to the piece-wise definition of the ALARA value; the break occurs where the first derivative does not exist.	127

Figure 38. Comparison of Marginal Risk Value (LNT) with marginal ALARA value at a watch level of 0.5 rem/year. Staff levels are incremented by 0.1 workers. The discontinuity is due to the piece-wise definition of the ALARA value; the break occurs where the first derivative does not exist. 128

Figure 39. Reprint of dose-bin averaged risks combined using a random-effects model. 134

List of Tables

Table 1. Attributes of detriment due to exposure of the working population. Figures were reported to 2 significant digits.	14
Table 2. Number of subjects, solid cancer deaths, and non-cancer disease deaths by radiation dose	24
Table 3. ERR Models for estimating incidence of all solid cancers excluding thyroid and non-melanoma skin cancers and mortality from all solid cancers. Parenthetical values represent 95% confidence intervals.	26
Table 4. BEIR VII Committee's preferred ERR model for estimating leukemia incidence and mortality. Parenthetical values are 95% confidence intervals.	26
Table 5. Detriment-adjusted nominal risk coefficients (10^{-2} Sv^{-1}) for stochastic effects after exposure to radiation at low dose rates [1].	27
Table 6. Cohort details for each of the four studies considered in this work.	63
Table 7. Fraction of fatal cancers among unexposed workers at various facilities.	64
Table 8. Details of Los Alamos Data Set.....	66
Table 9. Details of Hanford Data Set.....	67
Table 10. Details of the Rocky Flats Plant Data Set.....	69
Table 11. Details of Oak Ridge Data Set.....	71
Table 12. Results of hypothesis tests to determine homogeneity between the individual control groups and pooled control groups.	73
Table 13. Results of hypothesis testing comparing the unexposed populations between facilities.....	73
Table 14. Excess Relative Risk (ERR) per rem for each study	74
Table 15. Sex distribution of workers exposed to external ionizing radiation in the four studies examined in this work.....	75
Table 16. Relative risks from Los Alamos National Laboratory, Oak Ridge National Laboratory, the Rocky Flats Plant and the Hanford Site combined using the method developed in this work. Error bars represent 95% confidence intervals.....	77
Table 17. Relative risks from Los Alamos National Laboratory, Oak Ridge National Laboratory, the Rocky Flats Plant and the Hanford Site combined using the obsolescent method of Data Pooling. Error bars represent 95% confidence intervals.....	78
Table 18. Specifications for americium recovery Glovebox 1 modeled in MCNP5 [112].	92
Table 19. Specifications for americium recovery Glovebox 2 modeled in MCNP5.....	94
Table 20. Specifications for americium recovery Glovebox 4 modeled in MCNP5.....	98
Table 21. Time and motion data for primary plutonium processing. Times listed are in hours.....	105
Table 22. Time and motion data for secondary plutonium processing and americium extraction chromatography.	106
Table 23. Time and motion data for americium oxalate precipitation. Times shown are in hours.....	106
Table 24. Time and motion data for calcination and oxide handling processes. Times shown are in hours.	107
Table 25. Time and motion data for removing the batch from the glovebox line. Times shown are in hours.	108

Table 26. Total times for 1 and 25 complete americium operations. Background is the times spent with hands not in gloves. Background includes time spent in glovebox 3 the processes in which were not modeled.....	108
Table 27. Total times and whole-body doses for americium operations segregated by glovebox. "Yearly" values assume 25 operations per year. Time includes all time spent in the room including contact time.	115
Table 28. Photon and Neutron contribution to whole-body dose from each unit operation in the americium recovery project.	115
Table 29. Doses to the extremities per batch and per year for each operation broken down by glovebox. Yearly values assume 25 batches per year. Times presented in "Sum with Background" row represent the time spent out of gloves.	119
Table 30. Photon and neutron contributions from each unit operation modeled in the americium recovery project. Omits secondary background	120
Table 31. Dose incurred by employees with varying workforce sizes.	121
Table 32. Reprint of photon and neutron contribution to whole-body dose from americium recovery unit operations.....	135
Table 33. Fraction of workers from each study with doses recorded by film badge, thermoluminescent dosimeter or both. Estimated based on years of usage for each dosimeter type [126].	136

Chapter 1. Historical Analysis

1.1 Introduction

This research develops a new framework for evaluating the occupational risks of exposure to hazardous substances in any setting where As Low As Reasonably Achievable (ALARA) practices are mandated or used. The evaluation is performed by developing a hypothesis-test-based procedure for evaluating the homogeneity of various epidemiological cohorts, and thus the appropriateness of the application of data-pooling techniques to those cohorts. A statistical methodology is then developed as an alternative to pooling for situations in which individual cohorts show heterogeneity between them and are thus unsuitable for pooled analysis.

These methods are then applied to estimate the all-cancer mortality risks incurred by workers at four Department-of-Energy nuclear weapons laboratories: Los Alamos National Laboratory, Oak Ridge National Laboratory, the Rocky Flats Plant, and the Hanford Site. Both linear, no-threshold and dose-bin averaged risks are calculated and it is further shown that pooled analysis tends to overestimate the risks with respect to those calculated by the methods developed in this work.

The risk estimates developed in Chapter 2 are, in Chapter 3, applied to assess the risks to workers engaged in americium recovery operations at Los Alamos National Laboratory. The work described in Chapter 3 develops a full radiological protection assessment for the new americium recovery project, including development of exposure cases, creation and modification of MCNP5 models, development of a time-and-motion study, and the final synthesis of all data. This work also develops a new method of

determining whether administrative controls, such as staffing increases, are ALARA-optimized. The EPA's estimate of the value of statistical life is applied to these risk estimates to determine a monetary value for risk. The rate of change of this "risk value" (marginal risk) is then compared with the rate of change of workers' compensations as additional workers are added to the project to reduce the dose (and therefore, presumably, risk) to each individual.

This work develops, from basic epidemiological data, a framework for assessing ALARA practices at specific institutions. By developing institutionally-specific risks in the manner performed in this work (accounting for heterogeneity between cohorts and using the new methodology developed herein) and applying them to a risk-benefit analysis, it is possible to quantitatively determine whether the dose from a given practice is, truly, ALARA. Further, the risk-benefit analysis methodology provides a rational basis for estimates of ALARA-reasonable values.

1.2 Background

1.2.1 Quantities

Historical Dose Limits

The motivation for this project is almost as old as radiation protection itself. The interplay between the level of operational radiation protection and the cost of administering this protection has been contentious since the discovery of the biological effects of radiation in the late 19th century. Thus, a brief history (by way of literature review) of the development of the major organizations driving national dose limit policies

and the development of the policies themselves is necessary to place this work into context.

Even the most encyclopedic histories of radiation protection claim to be anything but complete, and this section is no different. The goal here is to present the development of the ideas that have influenced dose-management policies both in general and with a focus at Los Alamos National Laboratory (LANL, Los Alamos, the Laboratory). Before discussing the history of dose limits, a brief summary of the quantities and units typically used in radiation protection is provided. These definitions are based on the 2007 recommendations of the International Commission on Radiation Protection, ICRP (Report 103 [1]).

Absorbed Dose

The absorbed dose is a measure of the amount of energy deposited by radiation in a mass of matter; in a biological context, this matter refers to tissue. The current *Système International* (SI) unit of absorbed dose is the gray (Gy) defined as 1 joule deposited per kilogram of tissue. An older unit of absorbed dose is the radiation absorbed dose (rad) formally defined in 1953 in centimeter-gram-seconds (cgs) units as 100 ergs of energy absorbed in 1 gram of matter and in SI units in 1970 as 0.01 joule per kilogram of matter. In the United States, the standard unit is the rad; in the rest of world it is the Gy.

Equivalent Dose

Some types of radiation are more likely to interact with matter than others. For instance, an alpha particle is more likely to interact with matter than a photon.¹ The rate

¹ An alpha particle (a helium-4 nucleus) has 2 protons and 2 neutrons thus giving it a +2 charge and a mass of approximately 4 atomic mass units (amu). A gamma or x-ray (photon) has no mass and is electrically

per unit distance along a particle track at which energy is transferred from the particle to the medium in which it travels is called the Linear Energy Transfer (LET). Radiation types such as photons and electrons are considered low-LET radiation because they transfer relatively little energy per mean free path (mfp).² To take account for the different behaviors of different radiation types in matter, the absorbed dose can be weighted by a radiation weighting factor to determine the “equivalent dose.” Photons and electrons have weighting factors of 1, neutron weighting factors vary with energy, and alpha particles have a weighting factor of 20.

The SI unit of equivalent dose is the sievert (Sv). An earlier unit, still in use in the United States, is the roentgen equivalent man (rem). One sievert is equivalent to 100 rem.

Effective Dose

All organs in the human body do not have the same sensitivity to radiation. To account for these differences, the equivalent dose is weighted by tissue weighting factors accounting for the radio-sensitivity of various organs. The effective dose is then given by:

$$\text{Effective Dose} = \sum_R \sum_T D_{\text{Absorbed}} \times w_R \times w_T$$

where D_{Absorbed} is the absorbed dose to the whole body,³ w_R is a weighting factor where the subscript R refers to radiation type, and w_T is the tissue weighting factor. The units of

neutral. Therefore, owing to the relatively large-distance interactions related to coulombic forces, an alpha particle is far more likely to interact with matter than a photon.

² A mean free path is the average length a particle travels through a material before experiencing an interaction such as scattering or absorption.

³ The term “whole body” applies when the entire body is in an approximately uniform radiation field. There are separate limits for specific organs such as the lens of the eye and the extremities when the radiation field is not uniform.

effective dose are, similar to equivalent dose, the rem and the sievert. Unless otherwise specified, in this work the term “dose” refers to effective dose.

Committed Effective Dose

When radionuclides are ingested, inhaled, or otherwise transported into the body, the source of ionizing radiation is no longer external and a remnant will remain in the body continually producing ionizing radiation, i.e., the body is henceforth committed to receiving ionizing radiation at some level. The committed effective dose is defined by the ICRP as “the sum of the products of the committed organ or tissue equivalent doses and the appropriate tissue weighting factors... The commitment period is taken to be 50 years for adults and to age 70 for children” [1]. This is to say that, given biological elimination, the committed effective dose is the effective dose to an individual over a 50-year period (for adults) due to radiation resulting from the decay of radionuclides in the body.

Total Effective Dose

Total effective dose (TED) refers to the sum of effective dose from external sources and committed effective dose. In many occupational situations, such as plutonium workers at Los Alamos, committed effective dose is not considered when setting administrative limits on dose because all internal dose is purely accidental; ingestion or inhalation of radionuclides is never planned for in a laboratory setting (absent radiation treatments or other controlled dosages). Limits on committed effective dose become much more important for organizations employing workers in situations with a high likelihood of significant internal exposure (such as uranium mining).

The quantities of radiation protection are relatively new and improvements in the understanding of the biological effects of ionizing radiation have led to frequent changes in the paradigm of dose units. Below is a brief history of these developments.

1.2.2 History of Radiation Regulations

The Beginning

The age of radiation protection began with a group of factory women. In the 1920s, the biological effects of the internal deposition of radionuclides were still largely unknown. Russ [2] had defined a unit of absorbed radiation dose, the rad, as “the quantity of X-rays which, when absorbed, will cause the destruction of [a] malignant mammalian cell... .” Because polonium, radium, and the radioactive properties of uranium were all discovered between 1896 and 1898, industrial and medical uses of radionuclides were still new enough that large-scale public-health effects were not well known. One of the earliest industrial applications of radium was glow-in-the-dark paint. Alpha-particle emitters such as radium-226 can be combined with a luminescent powder such as zinc sulfide to make glow-in-the-dark paint well suited for watch and instrument dials. At the turn of the century, watch and instrument dials were painted by hand. A common practice among dial painters was to lick the tip of their paintbrush to make a sharp point for precise brushwork. However, in a facility using glow-in-the-dark paint, this practice resulted in the ingestion of large amounts of radium. The first recorded example of health detriment among the radium-dial painters was in a paper given by New York dentist Theodore Blum on a condition he called “radium jaw” [3]. In this paper he detailed the unusual and intractable nature of a case of osteomyelitis (bone infection) in the jaw of a young radium-dial painter. Other dentists in the area had noticed jaw necrosis in other radium-dial painters [4].

Because of the growing evidence of sickness among the painters, the New Jersey Consumers' League called an expert, F. L. Hoffman, to the plant. He found striking similarities among the death certificates of deceased former employees and inferred that this was due to a new type of industrial poisoning [5]. Simultaneously, researchers were observing “professional anemias” in radiologists and others involved in the medical application of radio-isotopes [6].

By 1925, it was clear that anemia and bone necrosis, including severe infection and leucopenia (a decrease in white blood cells), were common hazards of occupations with significant radionuclide-ingestion risks. This was so widely known by World War II (WWII) that when the US military began ordering watches and instruments with luminescent faces, they assured that standards would be in place to protect the dial painters. Robley Evans, a pioneer in early radionuclide toxicology, claimed that Navy Captain C. Stephenson was so insistent on prompt radium standards that he threatened to induct Evans into the Navy and assign him to the production of standards if they were not delivered in a timely fashion [4]. The result was perhaps the first example of a government-mandated occupational radiation-protection standard.

Standards for the protection against *external* sources of radiation, on the other hand, were born from the threshold dose-response concept. The first dose limits were based on the threshold beyond which medical radiologists observed erythema.⁴ This dose limit was called the threshold erythema dose (TED- not to be confused with Total

⁴ Erythema, or a reddening of the skin, was the first observable effect of exposure to ionizing radiation; sunburn is the most common example of radiation erythema.

Effective Dose); the dose acquired due to an exposure of about 300 to 600 roentgen(R).⁵ Mutscheller and Sievert independently recommended a tolerance dose (TD) of around 0.01 TED per month or roughly 0.1 to 0.2 R per day. This translates to approximately 100-200 mrem/day from photons.

Early Plutonium Standards

By the end of WWII, plutonium was being produced in kilogram quantities in the United States to support the development and production of nuclear weapons. Given the lessons learned over the years since the radium watch-dial painters, the US government was interested in determining the total amount of plutonium (a known α -particle emitter) that can be present in the body over a lifetime without causing ill effects (called the permissible body burden). In fact, the experience with radium provided a quantitative basis for the first plutonium standard. Robert Stone, the head of the Plutonium Project Health Division at the Metallurgical Laboratory (MetLab) in Chicago, made the earliest estimate of a permissible plutonium body burden, by scaling the radium standard on the basis of the radiological differences between radium and plutonium. This included differences in their radioactivities and those of their daughter nuclei as well as the difference in the average energy of their α -particles [7]. These results suggested that, on a per-mass basis, plutonium was less toxic than radium by a factor of 50 and that the permissible body burden was therefore set to 5 μg ($0.3 \mu\text{Ci}$)⁶ [7].

⁵ The roentgen is a unit of exposure defined as the amount of radiation required to liberate positive and negative charges equal to one electrostatic unit (esu) in one cubic centimeter of dry air at standard temperature and pressure. Where “dose” is a measure of the amount of energy absorbed in a mass of tissue and its effects,” exposure” is a measure of the magnitude of a radiation field.

⁶ The curie (Ci) is a unit of radioactivity equal to 3.7×10^{10} decays per second, which is the radioactivity of 1 gram of radium-226.

No sooner had these recommendations been made than the results of several toxicological experiments at the Metallurgical Laboratory (Met Lab)⁷ proved them inadequate [8]. These results suggested that ingested plutonium was distributed in bones differently, and more dangerously than radium. When Los Alamos learned of these results, Hymer Friedell, Louis Hempelmann, J.W. Kennedy, and Wright Langham, among others, met to discuss their impact on the 5 µg permissible body burden for plutonium. These meetings resulted in a reduction in the standard by a factor of 5 to 1 µg (0.06 µCi). Further discussions later at the Chalk River Conferences in Ontario led to further reduction in the permissible body burden for plutonium 0.65 µg (0.04 µCi).

This standard remained in place until 1977 when a fundamental change in the concept of radiation protection was brought about by the International Commission on Radiation Protection discussed in the following sections.

The Advising Organizations

In 1925, several countries joined together to organize an International Congress on Radiation Protection [9]. The International Congress soon realized that as the science and practice of radiology grew, so would the need for providing guidance on radiation protection. At the second meeting of the International Congress in 1928, the first meeting of the International Committee on X-ray and Radium Protection was held (ICXRP). Except for the period between 1938 and 1949, the ICXRP issued recommendations (primarily concerning external radiation sources) roughly every three years. After World War II ended, the ICXRP was replaced by the International Commission on Radiological Protection (ICRP).

⁷ MetLab was the name given to a Manhattan-Project-era facility directed by Arthur H. Compton at the University of Chicago charged with consolidating early nuclear weapons research.

Meanwhile in the US, the American Medical Association along with several radiological societies and X-ray equipment manufacturers agreed in 1928 to establish a radiation-protection committee. The purpose of this was to present a united front when interfacing as US ambassadors with international organizations. This organization was called the U.S. Advisory Committee on X-ray and Radium Protection (USAXRP) and Lauriston Taylor was elected chairman. Taylor worked for the National Bureau of Standards (NBS) and arranged for the Bureau to commit some resources to its management. The USAXRP remained under the NBS for roughly twenty years and issued most of its early reports as NBS handbooks.

When the USAXRP met in 1946 to revise the X-Ray Protection Handbook (NBS Handbook 20), they decided to reorganize to reflect the diversity of radiation protection topics. All U.S. organizations interested in radiation protection were to be included and the name was changed to the National Committee on Radiation Protection (NCRP). Another part of the restructuring was the development of subcommittees dealing with the various aspects of radiation protection, including a subcommittee on permissible internal dose, though neither the Committee nor the NBS had any statutory responsibility for radiation protection.

Formal Recommendations and Limits of the ICRP and NCRP

In the mid-1940s, the NCRP proposed an alternative to Tolerance Dose based on the Roentgen Equivalent Man (rem) called the maximum permissible dose (MPD). NCRP defined the MPD to be 0.3 rem per week or 15.6 rem/year under stipulated conditions of exposure; long-term exposures were subject to tighter limits. Permissible dose, in this context, was defined as "... the dose of ionizing radiation that, in the light of present

knowledge, is not expected to cause appreciable body injury to a person at any time during his lifetime.” [10] This definition still suggests an underlying dependence on the threshold concept.

Consideration of genetic effects and the growing fraction of the population that was susceptible to exposure led the NCRP to revise its recommendations in 1958. These new recommendations along with companion recommendations from the ICRP formed the basis of the US Atomic Energy Commission (and later the Nuclear Regulatory Commission) regulations that were in effect until the 1990s. They were similar to the regulatory limits of today with the exception that they were dependent on the age at which one received the dose. For example, for external exposure to whole body, head, trunk, active blood-forming organs, and gonads, the cumulative MPD was limited to $5 \times (N - 18)$ rem, where N is age at time of exposure. The NCRP maintained these recommendations until 1971, at which time the biological and epidemiological data had matured enough to support a more generalized system of radiation protection standards. In the meantime, the ICRP had further specified the definition of permissible dose, marking a shift from the threshold concept to the current linear-no threshold (LNT) scheme [11].

According to the ICRP report’s definition, the permissible dose for an individual is that dose, accumulated over a long period of time or resulting from a single exposure, which, in the light of the present knowledge, carries a negligible probability of severe somatic or genetic injuries. A negligible probability is still a probability, however philosophical, and demonstrates a fundamental paradigm shift in the concept of radiation protection.

The 1971 NCRP report modified the concept of acceptable risk to imply that a risk is only acceptable when it is offset by some benefit; it restricted the term MPD to occupational exposures while the term “dose limit” referred to a limit for the general population. The implications of this are two-fold; workers derive some benefit (monetary) from occupational exposure that the general population does not and that their work provides a societal benefit that offsets cancer risk to a small population. The argument can be made that the looser regulation on radiation workers is based upon their willingness to work jobs where radiation exposure is a concern [12]; the worker can quit at any time whereas the general population does not have that freedom. Thus, the general population’s unwitting exposures should be limited.

Early Risk Quantification

The rise of quantitative risk assessment in the nuclear industry instigated a transition from traditional standards to those based on quantitative risk. ICRP used the risk concept to explicitly state the linear, no-threshold dose-response relationship for carcinogenic and genetic effects; specifically, a 10^{-4} probability per rem whole body dose equivalent for malignant illness or a 4×10^{-5} probability per rem for hereditary illness within the first two generations of descendants [13]. For other radiation effects, however, absolute thresholds were assumed.

The current federal occupational limit of 0.05 Sv/year (5 rem/year) is based on the ICRP’s definition of “occupations with a high standard of safety” as being an occupation with an average annual death rate due to occupational hazards less than 100 per million workers. An acceptable risk was taken as 50 deaths per million workers per year, or a 40-year occupational lifetime risk of two fatalities per 1,000 workers (0.002

fatalities/worker). The ICRP assumed that the average radiological worker receives 1/10th the dose of the maximally exposed individuals with the doses highly skewed to the lower end of the spectrum. Thus, to ensure an *average* risk of 0.002,⁸ an upper limit of 10 times this value was placed on the lifetime risk for any one individual. The annual whole-body dose-equivalent limit for stochastic (effects which occur probabilistically such as cancer or hereditary effects) was thus taken as:

$$\frac{10 \times 40 \text{ year occupational lifetime risk}}{40 \text{ years} \cdot \frac{\text{prob}}{\text{rem}} \text{ whole body dose eq. (cancer)}} = \frac{10 \cdot 0.002}{40 \cdot 0.0001} = 5 \text{ rem / year} \quad (1.1)$$

For members of the public, ICRP assumed that everyday unavoidable risks result in a death rate of five deaths per year per million people, or a 70-year lifetime risk of about 4 per 10,000 people (a probability of individual death of 0.0004). It was observed that some individuals accept risks (car crashes, smoking) in everyday life an order of magnitude greater. Based on this probability, the whole-body dose-equivalent limit for stochastic risks to individual members of the public is:

$$\frac{10 \times 70 \text{ y lifetime risk}}{70 \text{ y} \times \frac{\text{prob}}{\text{rem}} \text{ whole body dose eq. (cancer)}} = \frac{10 \times 0.0004}{70 \times 0.0001} \approx 0.5 \text{ rem / year} \quad (1.2)$$

In their 1991 report, however, the ICRP revised this justification after determining that that it was not a satisfactory basis for the determination of dose limits. In that report they compared several “test values” of annual effective dose and evaluated the risk associated

⁸ Because the majority of workers were assumed to receive, on average, 10% of the dose to maximally exposed employees, if the limit were based on the average worker, the workforce-averaged risk would be far below the acceptable level. To take credit for this, the risk is multiplied by the factor of 10 and thus the risk averaged across the workforce was presumably maintained at the acceptable level.

with each value. The test values and the values for their associated “attributes of detriment” are reproduced Table 1.

Table 1. Attributes of detriment due to exposure of the working population. Figures were reported to 2 significant digits.

Annual Effective dose (mSv)	10	20	30	50	50 (1977 data)
Approximate lifetime dose (Sv)	0.5	1.0	1.4	2.4	2.4
Probability of attributable death (%)	1.8	3.6	5.3	8.6	2.9
Weighted contribution from non-fatal cancer	0.4	0.7	1.1	1.7	
Weighted contribution from hereditary effects (%)	0.4	0.7	1.1	1.7	1.2
Aggregated detriment (%)	2.5	5.0	7.5	12	
Time lost due to an attributable death given that it occurs (y)	13	13	13	13	10-15
Mean loss of life expectancy at age 18 years (y)	0.2	0.5	0.7	1.1	0.3-0.5

To assess which of these test values was optimal, the Commission defined three “words”⁹ to indicate the degree of tolerability of an exposure or risk. These words were “unacceptable,” “tolerable,” and “acceptable.” Unacceptable indicates that the exposure would, in the Commission’s view, not be acceptable on any “reasonable” basis in the normal operation of any practice in which its use was a matter of choice. Such exposures might have to be accepted in abnormal situations, such as those during accidents. Exposures not deemed “unacceptable” are subdivided into “tolerable” and “acceptable.” As their names would suggest, tolerable indicates that the exposures are “undesirable but can be tolerated” and acceptable indicates that “the system of radiological protection has been optimized.” [14]

Based on these definitions and the data in Table 1, the Commission concluded that the results indicate that their previous recommendation (as well as the current federal limit), a regular annual dose of 50 mSv (5 rem), is “probably too high and would be

⁹ The term “words” is used here as a direct quotation from the ICRP report.

regarded by many as being clearly so” [14] based on the expected loss of life expectancy at this level (1.1 years) and that the probability of attributable death exceeds 8%.

Ultimately, the commission decided the following:

On the basis of the data presented above, the Commission has reached the judgment that its dose limit should be set in such a way and at such a level that the total effective dose received in a full working life would be prevented from exceeding about 1 Sv received moderately uniformly year by year and that the application of its system of radiological protection should be such that this figure would only rarely be approached. The final choice of limits and the way in which they should be expressed are influenced by the way in which the limits will be applied in practice. The need to ensure that the limits provide protection against deterministic effects has also to be taken into account. [14]

The 1 Sv (100 rem) lifetime dose goal corresponds in Table 1 to the 20 mSv per year (2 rem per year) annual limit. Though the values for the attributes of detriment decreased in the most recent ICRP report, the Commission feels that these differences are of no practical significance and that the previous limits provide adequate protection [1].

In terms of setting a defined limit on lifetime effective dose, the commission sees difficulties in the practical applications of these types of limits. At the levels of dose incurred in normal situations, excluding doses to patients in radiotherapy, the control of stochastic effects could be based on the dose accumulated over periods of many years. However, such long control periods can be misused by allowing a rapid accumulation of doses and intakes near the start of a control period in the expectation, not always realized, of smaller doses later in the period. Flexibility of this kind also weakens the emphasis on achieving the control of exposures by design, transferring the emphasis to operational controls. [14] Thus, the ICRP does not recommend a limit on lifetime effective dose.

The 1977 ICRP report introduced limits based on committed dose equivalent and on tissue weighting factors capturing the various sensitivities of organs to radiation [13]. This report was a fundamental shift in the concept of internal radiation protection. Until 1977, standards had been based on the mass (or activity) of deposited material. The concept of tissue weighting factors was further refined in 1990 when the distinction was drawn between dose equivalent (H_T) and effective dose (H_E) [14]. Dose equivalent, as it was defined by the ICRP in 1977, is given by:

$$H_T = \sum_T w_T D_T Q_T, \quad (1.3)$$

which sums the product of the tissue weighting factor w_T , the tissue averaged absorbed dose D_T , and the radiation quality factor Q_T . The 1990 recommendation suggested the use of effective dose which accounts for both tissue target and radiation type:

$$H_E = \sum_T w_T H_T = \sum_T w_T \sum_R w_R D_{T,R} \quad (1.4)$$

Here, w_R is the tissue-independent radiation weighting factor and w_T is the radiation-independent tissue weighting factor.

From Recommendation to Regulation

The Atomic Energy Act of 1954 gave exclusive authority to a newly created Atomic Energy Commission (AEC) to regulate the use, transportation, and disposal of radioactive materials used in or produced by the nuclear fission process [15]. In 1955, the AEC published the first radiation protection regulations; Title 10 of the Code of Federal Regulations Part 20 (10 CFR 20) which became effective in 1957.

In 1974, the regulatory functions of the AEC were transferred to a new agency, the Nuclear Regulatory Commission (NRC). The radiation-protection regulations administered by the NRC in the 1960s, 1970s, and 1980s were based largely on the 1959 recommendations of the NCRP and the ICRP [16]. In 1994, revised regulations based on the methodology of ICRP 60 and adopting the limits expressed in NCRP 91 [17] were enacted by 10 CFR Part 50 and remain in place. The Department of Energy followed suit instituting identical limits in 10 CFR Part 835.

ALARA

The Linear No-Threshold risk model is the mathematical extension of the concept that there is no generally acceptable level of radiation exposure. However, radiological work is necessary if a society desires the benefit of nuclear medicine, nuclear-generated electricity, the security of a nuclear arsenal, or any of the enhancements made possible by nuclear science and engineering. Therefore, it is necessary to agree upon an “acceptable” level of risk.

Dose limits are regulatory definitions of what the regulating organization finds acceptable. In an attempt to reflect the advising bodies’ adoption of the LNT concept while still maintaining workable dose limits, both the NCRP [10] and the ICRP [18] strongly recommend that exposures are kept as low as practicable (ALAP), or in more common parlance, as low as reasonably achievable (ALARA). Current federal limits (both from the NRC and the DOE) mandate that their defined limits are to be implemented along with ALARA practices described briefly in the following paragraph.

ALARA, as it is defined by the ICRP, is based on three principals: keeping doses below regulatory limits, justifying dose-limitation practices by demonstrating a net

benefit and optimizing the radiation protection schemes by adjusting the worker's exposure time, their physical distance from the source, and the thickness and composition of the shielding. To examine the validity of an ALARA practice, both the cost of health detriment and the costs of radiation protection must be quantified and compared.

The ALARA concept is intentionally vague. Given the varied missions and budgets of organizations engaged in radiological work, it is impossible to make recommendations regarding what is and is not "reasonable" as far as radiation protection is concerned. At Los Alamos, "reasonable" is formally defined in the radiological procedure P121 [19] as \$2,000 per person-rem avoided and up to \$10,000 per person-rem avoided for individuals approaching their 2 rem/year Los Alamos administrative limit. The definition of "reasonable" at LANL has not changed in many years. While no justification is provided for the figures quoted in P121, a literature search shows several attempts to quantify an estimate of the reasonable costs per person rem avoided. Because the justification of the reasonable amounts is not provided by the radiation protection organization, this work attempts to evaluate the definition using methods from the literature.

A 200 \$/person-rem value was derived by J. E. Cohen in the early 1970s. [20] The values in the literature typically range from 10 \$/person-rem to 1,000 \$/person-rem, [21] though these numbers are not adjusted for inflation.¹⁰ The primary assumption of Cohen's analysis is based on a 1972 report of the BEIR committee, which calculates that exposing the entire US population to 5 rem per generation (defined as 30 years) or 170

¹⁰ The ICRP uses values in the range of \$10,000 to \$20,000 per person sievert (\$100 to \$200 per person rem) in the numerical results developed in their report.

mrem/year would eventually lead to an increase of 5% in the ill-health of the population [22]. Assuming annual US national healthcare expenditures (as of 2012) of \$2.8 trillion [23] leading to a cost of detriment of \$5 trillion based on Cohen's assumption that detriment is roughly twice the value of the total expenditures, increase in costs from radiation-induced ill-health become:

$$\$5.6 \times 10^{12} \times 5\% = \$2.8 \times 10^{11} \quad . \quad (1.5)$$

Also, assuming a US population of 311 million, a 30-year generation time and an exposure of 5 rem/generation, the value is calculated, based on Cohen's methodology, as:

$$\frac{\$2.8 \times 10^{11} / \text{year} \cdot 30 \text{ years} / \text{gen}}{5 \text{ rem} / \text{gen} \cdot 3.11 \times 10^8 \text{ people}} \approx 5,402 \text{ \$/person-rem} \quad (1.6)$$

Cohen calculates this figure as \$195 (in 1972 dollars) based on 1972 data (US health expenditures as \$65 billion and US population as 200 million). Accounting for inflation [24] this is equivalent to \$1,071 in 2012 dollars, almost 20% of the value calculated in Equation(1.6). This is primarily explained by the fact that, accounting for population increase, total US healthcare expenditures have increased by about 532% above inflation,¹¹ which would lead to a value of $(5.32 \times \$195)$ \$1,037 per person-rem avoided in 1972 dollars or \$5,696 in 2012 dollars. Further, increases in health costs could be influenced by the increase in the mean life expectancy in the US (71.2 years in 1972 to 78.3 years in 2010 [25]). This value of \$5,696/person-rem is near the middle between LANL's definition of "reasonable" for normal exposures (2000 \$/person-rem) and that

¹¹ 65 billion 1972 dollars is equivalent to 340 billion 2010 dollars. Taking the ratio of 2012 estimates of healthcare expenditures (\$2.8 trillion) to adjusted 1972 US Healthcare expenditures (340 billion) gives a value of around 8.24 (824%). The population however has only increased by about 155%. Therefore, the increase in health care expenditure (independent of population increase) is estimated as $824\%/155\%=5.32$.

for employees approaching the 2 rem limit (10,000 \$/person-rem), thereby providing some reasonableness to the current Los Alamos values.

There are several problems with using this methodology to set ALARA parameters in an occupational setting. First, the assumption that the cost of ill-health is about twice that of the total national expenditure is very rough and unsupported in Cohen's paper. Second, implicit in the use of 5-rem/generation in the calculation is that the cost per person-rem is for the general population exposed through environmental transport of radionuclides and not plant workers whose exposure would be somewhat higher, to a maximum of around $30 \times 5 = 150$ rem/generation. The 30-year/generation is based on first-generation genetic effects [22] though it is extended to "overall ill-health" through the assumption that between 5% and 50% of ill-health is proportional to the mutation rate. Using a value of 20% and a doubling dose (defined as the amount of radiation needed to double the natural incidence of a genetic or somatic anomaly) of 20 rem [22], the BEIR report calculates that 5 rem per generation would eventually lead to an increase of 5% of the ill-health of the population. However, as is acknowledged in the text, this report was written before the significance of radiation-induced cancer incidence was fully appreciated.

Many estimates of ALARA's "reasonable" definition are based on subjective judgments. Perhaps the broadest of these assumptions is that the cost of "ill-health" is twice that of national healthcare expenditures. This assumption is not present in the 1972 BEIR report where total US healthcare expenditures are used as a "lower bound" for cost of ill-health. A comprehensive evaluation of the costs associated with "ill-health" is necessary for the development of a cost of detriment in this fashion and requires detailed

knowledge of radiation effects at very low doses. The past 40 years has seen great strides in radiation epidemiology as well as radiation biology, though these advances are not sufficient to definitively determine the health-care cost associated with one rem.

1.2.3 Review of Dose-Response Models

Radiation Risk Assessment

In an occupational setting, radiation risk assessment typically consists of standard exposure calculations (using radiation transport codes) or measurements followed by the application of dose-to-risk conversion factors developed by committees such as the ICRP or the Committee to Assess the Health Risks from Exposure to Low Levels of Ionizing Radiation (BEIR¹²). Thus, this section of the review will be limited to the studies that have been most influential in the development of these risk estimates. It is noted here that the Health Physics Society issued a position statement advising against the estimation of radiation risks below 50 - 100 mSv (5 -10 rem) because at this level “risks of health effects are either too small to be observed or are non-existent.” [26]

The primary tool used to assess the risks to humans of exposure to ionizing radiation is epidemiology. Radiation epidemiologists use the term “risk” in two different ways to describe the associations that are noted in the data: relative risk and absolute risk [27]. Relative risk (RR) is the ratio of the rate of disease among groups having some risk factor, such as radiation, divided by the rate among a group not having that factor. Excess Relative Risk (ERR) is the relative risk minus 1. The second risk metric is the absolute risk (AR) which is defined simply as the rate of disease among a population. Excess Absolute Risk (EAR) is the difference between two absolute risks. The RR and ERR,

¹² BEIR is an acronym for Biological Effects of Ionizing Radiation.

being dimensionless, have mathematical advantages over the EAR and thus are more common in risk modeling applications.

Another common risk metric is the standardized mortality ratio (SMR). The SMR compares the mortality rate in some population against that in the general population from which the cohort of interest is drawn. An example of this would be a comparison of cancer mortality in West Virginia Coal Miners to the cancer mortality of West Virginians. In occupational radiation epidemiology, this metric often demonstrates a “healthy worker effect” (HWE) that results from lower mortality rates in the exposed population than in the general population. Metrics such as relative risk eliminate this effect because they compare exposed “healthy” workers to unexposed “healthy” workers.

The BEIR VII report [27], ICRP 103 [1], and the 2010 report of the UN Scientific Committee on the Effects of Atomic Radiation (UNSCEAR) [28] have all judged that the single most informative set of data on whole-body radiation exposure, cancer mortality and incidence comes from the life-span study (LSS) of the survivors of the 1945 atomic bombings in Japan. This study has been performed by the Radiation Effects Research Foundation (RERF) and its predecessor, the Atomic Bomb Casualty Commission.

The LSS continues to be a fruitful source of information about the effects of acute exposure to radiation as new analytical techniques become available [29]. As an example, in 2004 the RERF implemented an improved code for reconstructing doses in Hiroshima and Nagasaki. This dosimetry system was updated because reports in the early 1990s on thermal neutron activation measured in exposed material [30] [31] were interpreted as suggesting that the then-current survivor dosimetry system might systematically

underestimate neutron doses for Hiroshima survivors who were more than 1 km from the hypocenter. While this turned out to not to be the case, the new method showed that the previous system underestimated the gamma-dose by about 10% leading to an 8% underestimation in the risk estimates for solid cancer and leukemia [32]. Further, the large size of the population and the thoroughness of the follow-up allow for the analysis of less frequent endpoints, such as second cancers, usually prohibited by the small study size. A 2010 study of the A-bomb survivors found that radiation exposure confers equally high relative risks of second primary cancers as first primary cancers [33].

The full LSS cohort consists of approximately 120,000 persons who were identified at the time of the 1950 census. It includes 93,000 persons who were in Hiroshima or Nagasaki at the time of the bombings and 27,000 subjects who were in the cities at the time of the 1950 census, but not at the time of the bombings. This later group has been excluded from most analyses since the early 1970s because of inconsistencies between their mortality rates and those for the remainder of the cohort [27]. Table 2, based on the RERF's study of mortality in the LSS between 1950-1997 [34], shows the distribution of survivors in the LSS cohort by their estimated doses to the colon [32].

The dose to the colon is taken to be the gamma-ray absorbed dose to the colon plus the neutron absorbed dose to the colon times a weighting factor 10 (to convert it to dose equivalent). This weighted dose is in units of sieverts.

While the BEIR, ICRP, and UNSCEAR reports base their risk models exclusively on the results of the LSS, they recognize that acute exposures lead to higher risks than

protracted exposures. Thus, the LSS-derived risks were modified by a dose and dose-rate effectiveness factor (DDREF) [35] [27] [1].

Table 2. Number of subjects, solid cancer deaths, and non-cancer disease deaths by radiation dose

	Weighted Colon Dose (Sv)							
	Total	0 (<0.005)	0.005 - 1	0.1 - 0.2	0.2 - 0.5	0.5 - 1.0	1.0 - 2.0	2.0
Number of Subjects	86,572	37,458	31,650	5,732	6,332	3,299	1,613	488
Solid Cancer Deaths (1950-1997)	9,335	3,833	3,277	668	763	438	274	82
Non-cancer disease Deaths	31,881	13,832	11,633	2,163	2,423	1,161	506	163

The DDREF is a factor that divides the LSS risk estimates to account for the differences in the biological effects produced by differing dose rates. The BEIR VII committee combined radiobiological and epidemiological evidence concerning DDREF via a Bayesian statistical analysis. The data sets used were solid cancer in the LSS and cancer and life shortening in animals. The BEIR VII estimate of the DDREF ranged from 1.1 to 2.3 with a modal value of 1.5. The ICRP used “broad judgments in its choice of DDREF based upon dose-response features of experimental data, the LSS and the results of probabilistic uncertainty analysis conducted by others;” [1] their DDREF value was 2. The UNSCEAR suggested that if the dose-response curve over some dose range of interest can be approximated by a linear-quadratic function ($\alpha Dose + \beta Dose^2$) then the slope of the high-dose linear approximation at a particular high dose, D_H , is $\alpha + \beta D_H$, the slope of the low-dose linear approximation is α , and the DDREF corresponding to D_H is their ratio: $1 + \frac{\beta}{\alpha} D_H$. Thus, the UNSCEAR value of DDREF represents the curvature of the linear quadratic model and takes different values for different doses and model curvatures with values ranging from 1.5 to 7.0 [36].

The models used to evaluate the cancer risk from the LSS also differ among the different committees. For UNSCEAR, the shape of the cancer dose response is largely driven by assumptions made about the shape of the dose-response curve for the initiating lesion or lesions. In other words, the dose response for cancer is assumed to have the same shape as the dose response for initial damage. In particular, if the initial damage is a linear-quadratic function of dose, D , $F(D) = \sigma_0 + \sigma_1 \cdot D + \sigma_2 \cdot D^2$, then the cancer dose response will also be linear-quadratic, with the same ratio of quadratic-to-linear coefficients [35].

The risk model preferred by the BEIR VII committee is detailed below. For solid cancers the excess relative risk (ERR) is given by:

$$ERR(e, a)_{Solid\ Cancer} = \beta_s \cdot D \cdot e^{\gamma e^*} \left(\frac{a}{60} \right)^\eta, \quad (1.7)$$

where β_s is the gender-dependent ERR/Sv at an exposure age of 30 and attained age of 60, e is the age at exposure and e^* is $\frac{e-30}{10}$ for $e < 30$ and 0 for $e > 30$, a is the attained age, η is the exponent of attained age and γ is the per-decade increase in age at exposure over the range 0-30 years.

The parameter values for the BEIR VII committee's preferred model for solid cancer incidence and mortality are given in Table 3.

Table 3. ERR Models for estimating incidence of all solid cancers excluding thyroid and non-melanoma skin cancers and mortality from all solid cancers. Parenthetical values represent 95% confidence intervals.

Parameters	Incidence	Mortality
Male ERR/Sv (β_m)	0.33 (0.24, 0.47)	0.23 (0.15,0.36)
Female ERR/Sv (β_f)	0.57 (0.44,0.74)	0.47 (0.34,0.65)
Per-decade Increase in Age at exposure over the range 0-30 years (γ)	-0.3 (-0.51,-0.10)	-0.56 (-0.80,-0.32)
Exponent of attained age (η)	-1.4 (-2.2,-0.7)	-0.67(-1.6,0.26)

The BEIR VII committee selected a linear-quadratic model for leukemia incidence:

$$ERR(D, s, e, t)_{Leukemia} = \beta_s (D_{bone} + \theta D_{bone}^2) e^{\gamma e^* + \delta \ln\left(\frac{t}{25}\right) + \Phi(e^*) \ln\left(\frac{t}{25}\right)}, \quad (1.8)$$

where D is dose to the bone marrow in sieverts, and t is time since exposure in years. The quantities β_s , e and e^* are the same as above and δ and Φ are fitting parameters and θ is the curvature parameter taken to be 0.87 per Sv. The parameters used in the BEIR VII ERR model for leukemia model are given in Table 4.

Table 4. BEIR VII Committee's preferred ERR model for estimating leukemia incidence and mortality. Parenthetical values are 95% confidence intervals.

Parameter	Value
Male ERR/Sv (β_m)	1.1
Female ERR/Sv (β_f)	1.2
Per-decade Increase in Age at exposure over the range 0-30 years (γ)	-0.40 per decade (-0.78,0.0)
δ	-0.48 (-1.1,0.2)
ϕ	0.42 (0.0,0.96)
Curvature parameter (θ)	0.87 per Sv (0.16,15)

The ICRP, supporting a strict linear, no-threshold model [1] [37], chooses to present detriment-adjusted nominal risk coefficients for use in a model of the form βD where β is the risk coefficient and D is the dose. These nominal probability coefficients for cancer are based upon data on cancer incidence weighted for lethality and life

impairment. This differs from their previous coefficients, released in ICRP Publication 60 [14], which were based upon fatal cancer risk weighted for non-fatal cancer, relative life lost for fatal cancers and life impairment for non-fatal cancer. Unlike the BEIR model, the coefficients are not adjusted for sex or age at exposure. The nominal risk coefficients are given below in Table 5.

Table 5. Detriment-adjusted nominal risk coefficients (10^{-2} Sv^{-1}) for stochastic effects after exposure to radiation at low dose rates [1].

Exposed Population	Cancer (10^{-2} Sv^{-1})	
	<i>ICRP 103</i>	<i>ICRP 60</i>
Whole	5.5	6
Adult	4.1	4.8

Table 5 presents “detriment-adjusted” nominal risk coefficients. These are defined by the ICRP as the risks of harmful consequences (in this case cancer) of exposure to ionizing radiation weighted by the severity of the harm [1].

The basis for the ICRP risk model is presented in Appendix A of ICRP 103. This appendix includes the rationale for their models as well as some data on which they are based. Thus, it is possible to derive relative risks (on a per-sievert basis) directly from their data. For comparisons provided in the later chapters of this work, the relative risks were calculated by comparing the gender-averaged, all-cancer mortality per sievert to the gender averaged all-cancer mortality rate among Euro-American unexposed individuals. This resulted in a relative risk of 1.05 per Sievert ($5 \times 10^{-4} \text{ ERR/rem}$).

Scientific Basis for Various Dose-Response Models

Because of a lack of statistically significant evidence for any particular dose-response model at the very-low dose range [below 50-100 mSv (5-10 rem) for protracted exposures or 10-50 mSv (1-5 rem) for acute exposure], risks associated with these low doses are extrapolated from well-determined studies of higher doses. This literature review will now focus on the empirical basis for the most-often used dose-response relationships. In situations where advisory committees have issued position statements relating to any particular model, reviews of those positions are described. The most common models are described, and are presented graphically in Figure 1.

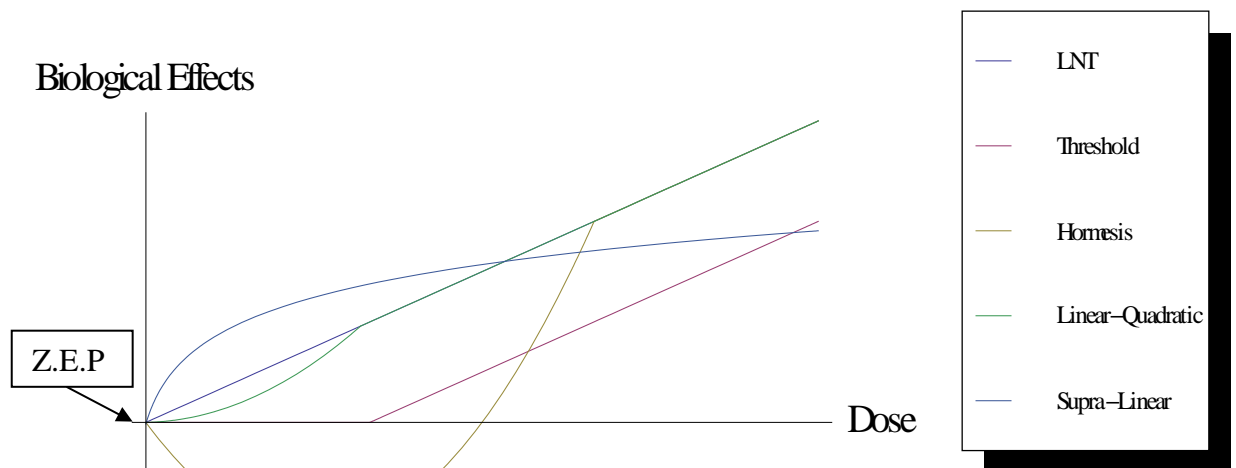

Figure 1. Schematic representation of several pertinent (notional) dose response models: linear, no threshold, linear threshold, hormesis, sublinear, and supralinear. The box to the left of the abscissa shows the “zero-equivalency point” (ZEP) which is the point at which there are no radiogenic effects. The sublinear and hormesis models follow the linear model above certain doses in this plot, though this is not necessarily representative of reality.

Linear Dose-Response Relations

At the low and intermediate doses that are amenable to statistically meaningful analysis, large amounts of data are available, both from epidemiological and laboratory studies that are consistent with a linear model [38]. This evidence has been analyzed in detail by the NCRP [39] and, more recently, by the ICRP [37]. The attitudes of both committees are summed up by the NCRP's statement in their 2001 report that "no alternate dose-response relationship appears to be more plausible than the linear-nonthreshold model on the basis of present scientific knowledge [39]." At lower doses, where epidemiological studies require almost impossibly large cohort sizes to make statistically significant statements, and where experiments are difficult because of inadequate shielding, biophysical models are valuable for gaining insight into the fundamental processes governing the cellular response to radiation. The biophysical rationale for linearity is based on the stochastic nature of radiation interactions. At a photon dose known empirically to carry an associated probability of detriment, most irradiated cell nuclei will be traversed by one or, at most, a few physically distant electron tracks (due to kerma¹³). Being so physically distant, it is very unlikely that these few electron tracks could produce DNA damage in some joint cooperative way; rather, these electron tracks will act independently to produce stochastic damage and consequent cellular changes. Because these tracks act independently, decreasing the dose will result in proportionally fewer tracks which proportionally decrease the risk of detriment [38]. For instance, if a dose with an associated risk is decreased by a factor of ten, the number

¹³ Kinetic Energy Released in Matter (KERMA) is defined as the expectation value of the energy transferred to charged particles per unit mass at a point of interest including radiative-loss energy but excluding energy passed from one charged particle to another [128].

of particle tracks would decrease by a factor of ten and the risk would decrease by a factor of 10.

Supra-linear (Concave) Dose Response

The supra-linear was seen earlier in the discussion of the most current results of the Life Span Study of the atomic bomb survivors; below around 0.3 Sv (30 rem) from the atomic bomb, the LSS data for cancer incidence and mortality both exhibit this shape [40]. These data are shown in Figure 2 which demonstrates the supra linear behavior in the low-dose range.

There are several interpretations of this dose response model. The first suggests that there exist small subpopulations of individuals within the total population who are hypersensitive to radiation [41]. The slope of the dose-response relationship for this subgroup would be steeper than the linear model used for the remainder of the population. Thus, in aggregate, the slope of the dose-response relationship would be somewhere between the normal and radiosensitive populations. No radiosensitive populations have been identified to date in the frequency and hypersensitivity necessary to affect a significant deviation from the linear model [38].

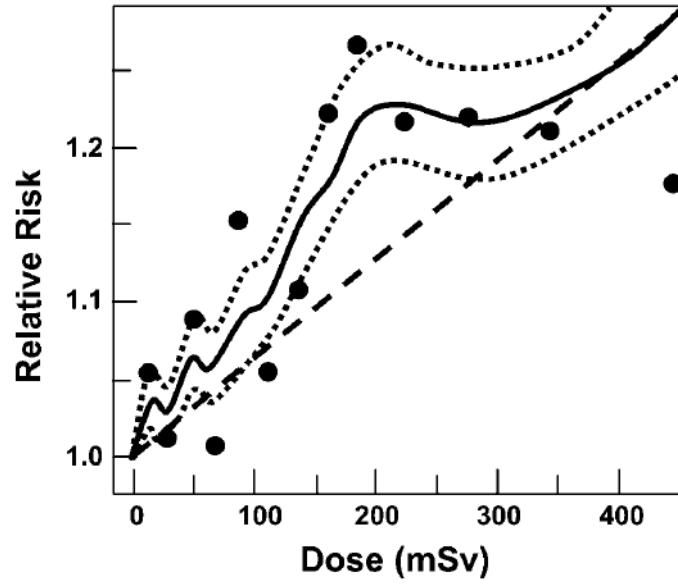

Figure 2. Estimated risks (relative to an unexposed individual) of solid cancer in atomic bomb survivors exposed to low radiation doses [40]. Data points are placed at the mean of each dose category. The solid curve represents a weighed moving average of the points shown (dotted curves ± 1 SE) and the dashed straight line is a linear risk estimate computed from all the data in the dose range of 0-2 Sv. Age-specific cancer rates from 1958-1994 are used, averaged over follow-up and gender [38].

An additional possible biological mechanism that could be responsible for the supra-linear model is induced radio-resistance in which a small “priming” dose decreases the radiosensitivity of the irradiated cells to subsequent larger radiation exposures, possibly by up-rating DNA repair mechanisms [38]. This has been demonstrated for carcinogenesis [42] as well as other detrimental cellular effects.

The argument for linearity presented in the previous section assumes autonomous response for individual cells; it would not necessarily hold if multiple damaged cells acted cooperatively as has been empirically shown to be the result of radiation bystander effects [43]. The bystander effect explains the phenomenon of cells not directly hit by a radiation track being adversely affected. This is thought to be caused by intercellular signaling from “hit” cells that could potentially induce oncogenic damage to neighboring

cells. In this case, the cellular response to a dose of ionizing radiation would be underestimated by the linear model described above.

Linear Threshold Model

The threshold model suggests that there is some dose level below which radiation has no cellular or biological effects. One of the first arguments for a threshold model was made by radiation protection pioneer Robley Evans who suggested that, even assuming the linear, no-threshold model, the latency period for tumorigenesis resulting from doses below a certain threshold is likely longer than the exposed individual's remaining lifespan [44]. An empirical example of a threshold is the lack of an elevated risk of sarcoma (bone cancer) mortality among the atomic bomb survivors while a statistically significant increase in carcinomas was observed. Thus, it is thought that a threshold model is appropriate for sarcoma, though not for carcinoma [45]. An upper limit on a threshold was estimated for the atomic bomb survivors in 2000 by the radiation effects research foundation as 0.06 Sv (6 rem) [40]. This was estimated by finding the upper limit of a 95 percent confidence interval for the dose-intercept of the linear, no threshold model. Other studies' estimates of a carcinogenetic threshold value have ranged from 40 mSv to 200 mSv (4 rem- 20 rem) [46].

Some support for the linear threshold model comes from epidemiological studies comparing populations exposed to varying levels of background radiation. An example provided in the BEIR V report demonstrates that the population of Guodong Province in the Peoples' Republic of China who were exposed to 3-4 mGy (300-400 mrem) per year experienced no increase in cancer over a control population exposed to around 1 mGy

(100 rem) per year [47]. A calculation by the BEIR VII committee suggested that, assuming the linear, no-threshold model, the expected percentage of cancers induced by the excess background radiation would be 1-2% above the cancers occurring from all other causes in a lifetime [27]. This is an example of what epidemiologists refer to as an ecological study, and is not considered sufficient to demonstrate causality. Ecologic studies compare population data as opposed to individual data; because populations are likely to differ by more than just the exposure, and confounders cannot be controlled, the use of these studies is considered highly tenuous. Further, it is unclear if a 1-2% difference in cancer rates could be detected by epidemiological methods [27].

Hormesis

The basic thesis of hormesis, from a cell-biology perspective, is that the stress responses activated by low doses of radiation, particularly those that would increase immunological responses, are more beneficial than any deleterious effects that might result from the low doses of ionizing radiation [27]. In other words, low doses of radiation would, under this theory, provide a benefit greater than their associated risk. This effect has been demonstrated in animal studies [48] where animals exposed to low and intermediate levels of ionizing radiation experienced increased longevity. In many of the cases presented in Upton's review, the increase in longevity was primarily to the result of a strengthened immune system, and not necessarily a decrease in malignancies. This suggests that, in these studies, any increase in lifespan would be due to a radiation-induced enhancement of the immune system [49] as opposed to improved DNA-repair mechanisms [50].

More recent results suggest that bystander effects, thought by some (as discussed above) to contribute to a supra-linear dose response, may actually provide a protective effect to neighboring cells as opposed to damaging them [51] [52].

In epidemiology, the existence of negative associations between dose and risk is not uncommon in case-control studies. A combined study of cancer mortality at three DOE facilities engaged in nuclear weapons and plutonium work [53] showed negative excess relative risks for all cancers and for leukemia [54]. A study of Canadian workers employed in the nuclear fuel cycle showed a negative trend in cancer mortality with increasing dose [55]. Other evidence comes from ecologic studies of populations exposed to high levels of background radiation [56] [57] [58] and domestic radon exposure [59] [60]. However, as discussed above, the use of ecological studies to infer causation is questionable.

Convex Dose-Response Relationships (Sublinear)

A convex dose-response relationship suggests that the linear, no-threshold model overestimates risk at low doses, while underestimating the risk at high doses. This type of relationship is typically used to describe the acute dose-effect relationship for radiation-induced leukemia in humans [34]. This relationship is also a consequence of current cell-survival and mechanistic cell-repair models [61], thus demonstrating its compatibility with radiation biology.

The Practical Application of Dose-Response Models

Estimating the risk associated with human exposure to ionizing radiation is controversial. The currently accepted basis for risk-based radiation protection is to assume that risk increases linearly with increasing dose (the linear, no-threshold

hypothesis) [37]. The logical extension of the linear, no-threshold (LNT) theory is that at a sufficiently small dose, D , and sufficiently large population size N , exposure of N people to an average dose D would result in the same number of radiation-related cancers as exposure of $k \times N$ people to an average dose D/k for arbitrary $k > 1$. The ICRP emphasizes in this report that the practical significance of this issue is only associated with doses leading to risks that are high enough to be of 'legitimate' concern as determined by the "usual social and political processes" [37]. This is to say that, assuming the LNT model, there will be a dose level below which the associated risks are less than those routinely taken in everyday life. The ICRP's current recommendations are based on this concept of "acceptable" risk as is ALARA practice.

The dose level that is considered reasonable, however, would change if the LNT model was not assumed; a supra-linear model would increase the acceptable dose level and a linear-threshold or sub-linear model could reduce it. A hormetic model would, in practice, be equivalent to a threshold model because, below the point where the risks become positive, radiation exposure would provide a beneficial effect and thus be of no concern from a radiation-protection standpoint.

Occupational Dose at Los Alamos National Laboratory

For glovebox workers at the Los Alamos Plutonium Facility at TA-55 (PF-4) and the Chemistry and Metallurgy Research Building (CMR), incurring dose is a routine occurrence. The main exposure concern is external dose from neutrons and photons. However, there is a possibility of radionuclide ingestion in the event of accidental puncture of glovebox gloves or failure of the ventilation system.

The previous section examined the history and rationale for national and international radiation protection standards. Now the focus is narrowed to department of energy facilities and the rationale for current dose limits.

1.2.4 Design Goals and the Evolution of Occupational Risk

Newly designed DOE radiological facilities have set design goals of 500 mrem/year to the maximally exposed employee [62]. While these are not operational administrative limits, they do belie a fundamental shift in the philosophy of radiation protection away from keeping doses ALARA to as low as possible (ALAP). As will be seen in Chapter 3, it is not uncommon to find facility background doses higher than this level. One problem that the americium project faces, which motivates the risk-benefit analysis performed in this work, is that the background dose in the room where the gloveboxes are located possesses a dose rate equal to (on average) the current design objective (1 rem/year for a 2,000-h work year).

Were the ALAP philosophy applied to binding administrative limits, it would undoubtedly increase the costs associated with many operations. While most workers (around 96% as shown below) receive less than 500 mrem/year, there are a non-trivial number who historically received greater than this amount. As an illustration, Figure 3 shows the fraction of employees at Los Alamos who have received greater than 100 mrem (the current ICRP recommendation and NRC limit for dose to members of the general public) and 500 mrem each year since 1990 through 2012. Since 1990, an

average of 4.3% of the workers receive greater than 500 mrem, an average of 22.7% receive greater than 100 mrem.

An aspect of this research seeks to evaluate, from an ALARA perspective and based on the best available data, if this philosophy is reasonable. Before examining this problem in detail, a historical review of radiation exposure at Los Alamos National Laboratory is presented.

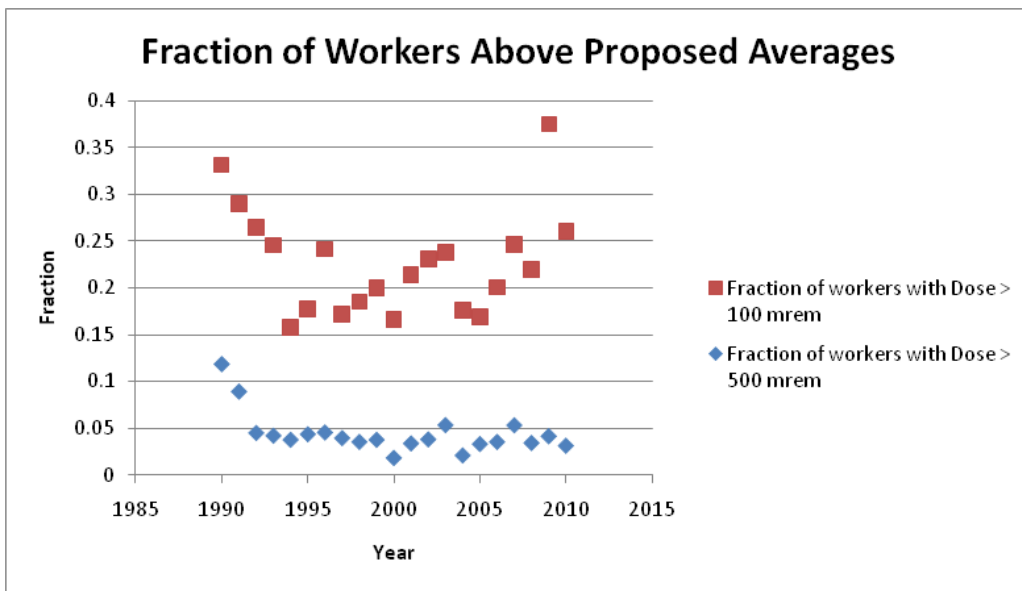

Figure 3. Fraction of exposed Los Alamos workers exposed to ionizing radiation at doses exceeding 100 and 500 mrem in a year.

1.2.5 Los Alamos Dose Records and Historical Events

Los Alamos National Laboratory, one of the largest science and engineering institutions in the world, was home to the Manhattan project to develop the world's first atomic bombs. Spencer Weart wrote of uranium in his history of the scientists involved in the development of the atomic bomb [63]:

We must be curious to learn how such a set of objects - hundreds of power plants, thousands of bombs, tens of thousands of people massed in national establishments - can be traced back to a few people sitting at laboratory benches discussing the peculiar behavior of one type of atom.

The radiation resulting from the fission and decay of nuclei including Weart's "one type of atom" and its consequences have been the source of intense debate and analysis in the past century. Collective dose (the sum of the doses received across the entire exposed workforce) at a radiological facility over time can tell the story of the activities that have occurred. Los Alamos has been maintaining dose records since 1944 that provide an excellent correlation with the history of the Laboratory. Both the trends and outliers in this data help identify significant events in Los Alamos history as shown in Figure 4. Significant events were identified using the criterion of a standardized difference greater than 2 indicating that the dose had changed by more than 2 standard deviations since the previous year. The standardized difference is given by:

$$\frac{D_1 - D_2}{\sigma} \quad (1.9)$$

The primary question in this method is how to choose a standard deviation; Figure 4 demonstrates that there are several significant "eras" in the Laboratory's history each with distinct dose profiles. These eras have such different activity profiles that it is unreasonable to apply the same standard deviation to each. Because one of the most influential factors in Laboratory activities is the Laboratory director, the differences were standardized to the standard deviation of mean dose during each director's tenure. In doing so, it is possible to identify significant events during an era that may not have appeared if the standard deviation for the entire history of the Laboratory were used.

As is discussed above, radiation dosimetry practices were well developed for X-ray and radium assessment by the start of the Manhattan Engineer District (MED) program to develop nuclear weapons in 1940. The primary challenges encountered by the MED and later by its successor, the Atomic Energy Commission (AEC), were how to measure worker dose to external radiation involving neutrons or mixed radiation fields. Uncertainties in these measurements in the early days of the MED operations at Los Alamos were accounted for by ORAU when reconstructing the doses reported in the Los Alamos dose database used for this analysis [64].

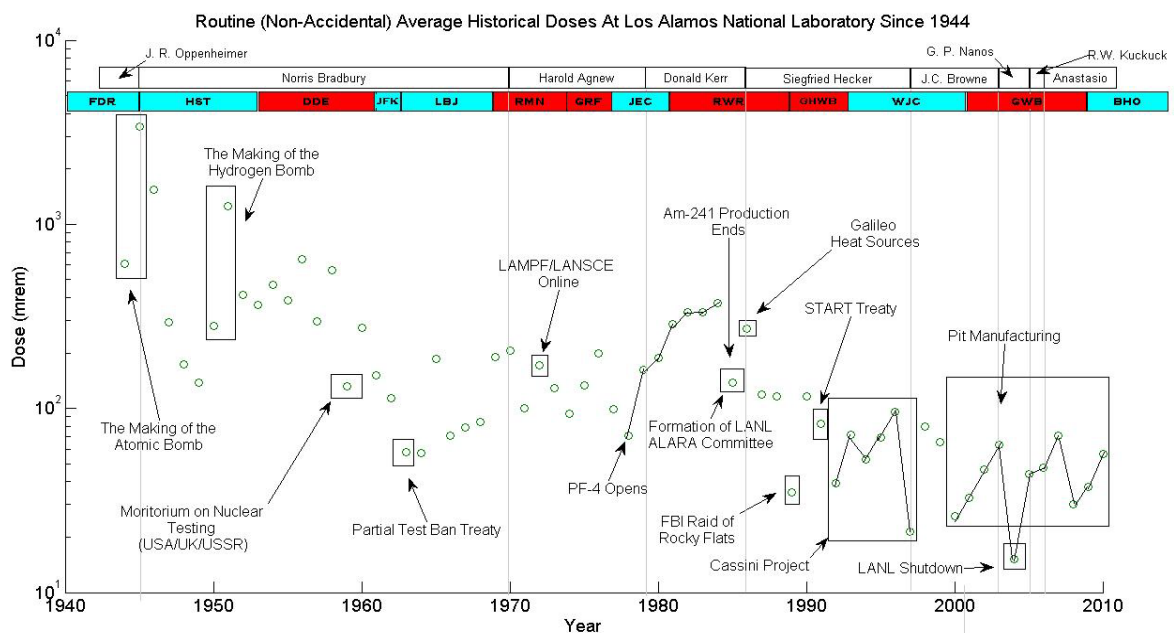

Figure 4. Routine (Non-accidental) average doses by year at Los Alamos National Laboratory. The white boxes at the top show the Laboratory directors' names. The colored boxes show the president color-coded by political affiliation (red for republican, blue for democrat).

As is expected, doses experienced a significant increase between 1944 and 1945 because of the workforce demands of the Manhattan Project. During this time, work

assignments included performing the final purification of plutonium received at Los Alamos, reducing plutonium to its metallic state, determining the relevant physical and metallurgical properties of plutonium and developing weapon component fabrication technologies [64]. Processes associated with these assignments included nuclear fuel fabrication, nuclear criticality experimentation, radiochemical separations, refining, finishing and storing plutonium and various other processing and testing operations. With the exception of component fabrication, these operations entailed significant exposures to various types of radiation.

After 1945, when World War II had ended and J. Robert Oppenheimer had left, the dose began to decrease as the Laboratory began transition to a more general scientific focus. This changed in 1951 with the first stages of the development of the world's first thermonuclear weapon, the Hydrogen Bomb, culminating on November 1, 1952 with the Ivy Mike shot at Eniwetok.

In 1952, the Rocky Flats Plant opened and some production work was shifted there from Los Alamos. This is likely a contributor to the downward slope between 1952 and the opening of PF-4 in 1978, when the manufacturing paradigm shifted and people learned to use the new facility.

Mounting public concern over the Cold War as well as the fallout from nuclear weapons testing in the mid-1950s [65] led governments to begin discussing the possibilities of testing bans and moratoriums; Los Alamos doses decreased accordingly. In 1958, during negotiations for a comprehensive nuclear test ban at the Geneva Conference on the Discontinuance of Nuclear Weapons Tests, the United States, United

Kingdom, and the USSR agreed upon the first large-scale moratorium on nuclear weapons testing. During this moratorium, doses decreased sharply and, though they increased immediately after it expired at the end of 1959, they never returned to the pre-moratorium levels. From 1960 until the signing of the Partial Test Ban Treaty (PTBT) in 1963, doses steadily decreased to some of the lowest levels the Laboratory has seen. Though in the years following the PTBT doses appear to fluctuate greatly, they remain within a reasonable range for the Norris Bradbury era.

In 1970, Norris Bradbury was replaced by Harold Agnew. The Agnew era was not characterized by the large standard deviations in average dose of the Bradbury era despite the fact that it saw several important changes to the Laboratory. The early days of the Agnew era saw the opening of the Los Alamos Meson Physics Facility (LAMPF) in 1972 (currently named the Los Alamos Neutron Science Center, LANSCE). While these facilities tend to focus more on basic science applications than weapons engineering and production, they still represent significant exposure risks to the operators, maintenance technicians, and scientists involved in their operation. No significant trend in the Laboratory-wide average doses appeared in the five years following the opening of LANSCE/LAMPF (1972-1977).

One of the most significant events in the recent history of the nuclear weapons complex was the opening of Plutonium Facility 4 (PF-4) in 1978 which, over thirty years after its opening, remains the nation's most advanced plutonium processing facility. Harold Agnew left the Laboratory the year after PF-4 opened and was replaced by Donald Kerr. The opening of this facility began the first of several multi-year trends that characterize the modern Laboratory. From 1978 through around 1989, the utilization of

PF-4 increased as purified plutonium metal began to be provided to the Rocky Flats Nuclear Weapons Plant. This increase corresponds directly to an increase in Laboratory-wide average dose through 1984. In 1985, Los Alamos' first ALARA committee was founded [66], cementing the Laboratory's commitment to a work-practice philosophy of justification, optimization and dose limitation, and the acceptance of the new ICRP 26 philosophy [13]. This commitment manifested itself in a significant decrease in doses in 1985. Doses rose sharply in 1986 due partly to the Laboratory's role in the production of Pu-238 heat sources and Radioisotope Thermoelectric Generators for the Galileo mission to Jupiter. However, with the exception of 1986, doses have never risen above their pre-ALARA committee levels. An additional factor contributing to the sharp reduction in dose between 1984 and 1985 was the cessation of the first americium recovery project. The institution of the ALARA committee may be the most important event of the Donald Kerr era from a radiation protection perspective. Kerr was replaced in 1986 by Siegfried Hecker.

In the late 1980s, significant mishandling of chemical and transuranic waste at the Rocky Flats plant led to heavy fines from the Environmental Protection Agency (EPA) and eventually, Federal Bureau of Investigation (FBI) involvement. On June 6, 1989 the FBI served the DOE with a search warrant while simultaneously raiding the plant. Despite no similar mismanagement problems at Los Alamos, programmatic work was significantly (albeit temporarily) hampered by the introduction of "Tiger Teams" intended to ensure that Los Alamos was compliant with all government regulations. This decrease in productivity is evident in Figure 4 where the average dose shows a steep decline relative to the surrounding years.

The more recent history of the Laboratory can be characterized by two large-scale projects: the production of plutonium heat sources for the Cassini space probe and the pit manufacturing endeavor. Both of these programs are boxed and labeled in Figure 4. The departure of Siegfried Hecker coincided with the end of the Cassini program, though no correlation is implied. Hecker was replaced by John Browne who saw the birth of pit manufacturing in 2000. From the inaugural year of pit manufacturing (2000) until 2003, the collective doses increased significantly. In 2003, Browne left the Laboratory and was replaced by former rear admiral G. Peter Nanos.

In July 2004, during a special inventory associated with an upcoming experiment, two items of Classified Removable Electronic Media (CREM) were discovered missing from the Weapons Physics (WP) Directorate [67]. In response, director Nanos suspended programmatic work at the Laboratory. The following is an excerpt from the email memorandum sent to all employees [68].

The Senior Executive Team and I have taken the extraordinary step of broadening the work suspension to include all activities at the Laboratory. We are doing this as part of an effort to ensure this Laboratory operates safely and meets our national security obligations. This action is not due to lack of confidence in your ability to do your jobs, nor is it punitive in any way. I'm simply convinced that we need time to reflect on our shared responsibilities and on how we do our jobs... I want you to be aware how serious this situation is, and I will keep you informed about what will be happening in the next few days. This week I traveled to Washington D.C. and to Oakland where I met with our customers, members of Congress, UC Regents and University management. Frankly, nobody understands how we have gotten ourselves into this mess. I told them that, in accordance with our policies, people will be terminated if they ignore the safety, security and environmental regulations that are at the core of what we do here. I emphasized to everyone I met with that this willful flouting

of the rules must stop, and I don't care how many people I have to fire to make it stop. If you think the rules are silly, if you think compliance is a joke, please resign now and save me the trouble... You may already have seen media accounts of what individuals are saying about the Laboratory and these recent events. Perhaps this outside view will help you understand just how serious this situation has become... People who believe their dedication to science or to our mission supersedes our commitments to safety, security and environmental compliance put us all at risk. This erroneous belief puts our personal safety on the job, our nation's security which depends on protecting classified information, and the institution to which we've dedicated our careers at risk. After the all-hands meeting, I received a lot of feedback from you and I appreciate the time and thoughtfulness you put into your messages. I was especially gratified by one note in which a group of employees talked about the "institutional embarrassment" of the current situation and their collective sense of outrage at the actions of a tiny minority.

It was later discovered that the missing hard-drives had never existed and that the scandal was the result of faulty classified-matter accounting practices. The Laboratory resumed normal operations later that year to major organizational changes [69]. Nanos stepped down in 2005 and was replaced by Robert W. Kuckuck, who was the last Laboratory director under the University-of-California-managed Laboratory.

Kuckuck remained as director until June 2006 when the Los Alamos management contract was awarded to Los Alamos National Security, LLC (LANS) which was made up predominantly of Bechtel, University of California, Babcock and Wilcox, and URS Energy and Construction. Michael Anastasio, then head of Lawrence Livermore National Laboratory, was named first Laboratory director under LANS effective June 1, 2006. The director-based standard deviations used in the standardized difference described above monotonically decrease during each director's tenure from Oppenheimer

to the Nanos/Kuckuck era. The first increase in standard deviation over previous eras was in the five years since Los Alamos National Security took over the Laboratory. This is largely due to a dip in 2008 presumably because of the relocation of much of the Laboratory's transuranic waste to the Waste Isolation Pilot Plant in Carlsbad, NM.

In early 2009, an employee was caught attempting to smuggle roughly \$2,000 of gold shavings out of PF-4 in a sandwich bag when he set off one of the radiation monitors workers must pass through when exiting the facility [70]. In response, a "two-person rule" was instituted in PF-4 mandating that no worker can enter PF-4 without an escort and that no worker is left alone at any time. The two-person rule necessarily increases the Laboratory's average dose considering that for any operation with an associated exposure, the worker's "second" will receive a dose that they may not have had. While this correlates in time to a noticeable rise in average dose, the rise is not as sharp as is associated with some previous events such as the year after the 2004 shutdown.

From this analysis, it is clear that the recorded doses at a facility correlate with the facility's work scope and activity. In some ways, the dose database provides the more reliable history of the Laboratory than any historical report can. The task is to decode the messages provided.

1.3 Chapter Conclusion

Radiation protection, as a science, is still very new. The recommendations and regulations governing the low-level exposures typical of occupational settings have historically depended on the use of broad assumptions and the use of conservative estimates in the absence of definitive scientific data. While the life-span study of the

Japanese atomic bomb survivors provides a wealth of information about that particular cohort, it necessitates the use of dose-and dose-rate effectiveness factors (DDREF) to be applicable to radiation workers receiving protracted low doses of ionizing radiation. Further, cultural factors, genetic predisposition to various ailments, and other confounding factors must be taken into account. Thus, the future of radiation protection must move away from the current paradigm of calculating risks based on the Life Span Study and incorporating other information merely in the DDREF.

The purpose of this dissertation is to develop methods for improved estimates of the risk due to exposure to ionizing radiation and to apply these methods in a novel manner to the problem of ALARA optimization. Chapter 2 examines the necessity of homogeneity among cohorts in the development of risk estimates from epidemiological studies and proposes a method for handling heterogeneous cohorts. Further, this method is applied to estimate all cancer risk in four Department of Energy nuclear weapons laboratories.

Chapter 3 develops a radiation exposure assessment for an example process at Los Alamos National Laboratory and applies the cancer risks developed in Chapter 2 to estimate whether the change in compensation the worker is paid is commensurate with the change in risk the worker experiences. This, along with two other methods are proposed as new paradigms for determining whether staffing requirements result in a radiation protection scheme that keeps doses as low as reasonably achievable.

Chapter 2. Radiogenic Cancer Risk: Methodology and Estimation

2.1 Introduction

The purpose of this study is to demonstrate that the epidemiological technique of aggregate pooling is inappropriate for the combination of some seemingly homogeneous populations, and to develop an alternative method for combining epidemiological studies. Further this work applies this technique to the case of occupational radiation exposure to develop all-cancer risk estimates for Department of Energy weapons-laboratory workers.

Scientific understanding of the risks due to exposure to ionizing radiation has improved over the years because of advances in radiobiology and epidemiological studies of exposed populations. However, determination of the risks from exposure to low doses of ionizing radiation is difficult because both the cohorts and the biological risks are small and will likely be confounded by environmental or lifestyle factors such as smoking or genetic disposition to various health conditions. Epidemiological techniques such as the pooling of different populations into one study can increase the statistical power of risk estimates in situations where the exposed population is too small to allow differentiation between dose effects and confounding factors. However, as this work will demonstrate, if the populations being examined do not show sufficient homogeneity between them (including between the exposed and unexposed populations) pooling can lead to erroneous results. Often, when studies are pooling diverse populations, care is taken to define groups that possess a high degree of homogeneity. An example of this approach to pooling is the 15-country study of nuclear workers [71]. The 15-country study examined epidemiological data from 15 countries and included both weapons laboratory workers and commercial nuclear power workers and significant effort was made to ensure that workers were grouped homogeneously. The death rates within these

groups are then compared to national death rates to calculate standardized mortality ratios (SMR), where homogeneity is practically impossible. As expected with SMR estimates of nuclear workers, a healthy-worker effect is seen. When the cancers deaths were stratified by dose and fit to a linear excess relative risk (ERR) model using Poisson regression, statistically significant positive correlations were seen [72], likely due to the choice of a linear model. The results from this study are not easily summarized and thus a table is not presented here.

Many of the epidemiological studies of nuclear weapons laboratory workers exposed to radiation in an occupational setting have focused on internal exposure to plutonium [73] [74], [75]. This has been especially true of studies concerning Los Alamos National Laboratory [76] [77] [78] [79]. One of the most interesting studies has been the 50-year follow-up of 26 Manhattan Project workers exposed to internally deposited plutonium [80] [81] [82] [83] [84]. The workers were examined periodically between 1971 and 1994. Their effective doses ranged from 0.1 to 7.2 Sv with a median value of 1.25 Sv [80]. By the end of the study, seven individuals had died, which was less than half of the expected 16 deaths predicted by a survey of the US population. Their death rate was also lower than unexposed workers employed at Los Alamos National Laboratory over the same period of time. Eight of the twenty-six workers had been diagnosed as having one or more cancers, which was within the expected range. The underlying cause of death in three of the seven deceased persons was from cancer, namely cancer of prostate, lung, and bone. Mortality from all cancers was not statistically elevated [84].

Many of these studies reported exposure data for internal and external dose, though the ultimate goal of the study was to gain a further understanding of the effects of plutonium on the human body. Few studies have focused exclusively on exposure to external sources of ionizing radiation in these populations [53] [85] [54]. The lack of studies examining external exposure in the (approximate) absence of internal contamination is likely due to small cohort sizes (made smaller by the exclusion of workers with measurable levels of internal contamination) and low-level exposures [86]. Thus, many of these studies use methods, such as pooling, to combine the results from cohorts that are approximately similar across several dimensions such as socio-economic status and racial makeup. As this work will show, latent heterogeneities between the populations can affect the results of epidemiological analysis. Thus, to avoid a “heterogeneity bias,” risk metrics that compare the exposed and unexposed populations in each study must be calculated first and then combined in a statistically appropriate way.

Thus, this work presents a hypothesis-testing procedure that will allow for the evaluation of homogeneity between the studies as well as an alternative method for the combination of studies of heterogeneous populations. This methodology is based on the statistical method of Whitehead and Whitehead [87] applied to regression analysis as well as the combination of dose-bin-average relative risks.

2.2 Background

Occupational radiation epidemiology studies provide important insight into the macroscopic effects of exposure to low levels of ionizing radiation in humans. Oak Ridge Associated Universities (ORAU) along with the Oak Ridge Institute for Science and Education maintains a database of both raw and processed epidemiological data from

published studies called the Comprehensive Epidemiological Data Resource (CEDR) [88]. The datasets contained in CEDR were collected and combined using two methods to compare current risk models to estimate the risk to the workers. Combining studies is especially important in radiation epidemiology where cohorts are often too small to infer statistically significant conclusions.

Each of the studies considered in this work, represents socio-economically similar cohorts in that studies of DOE workers in similar facilities are similar in education, age, and race [53]. Radiation workers at Department of Energy facilities tend to be relatively well educated, have good health insurance, have a high standard of occupational safety, and have government security clearances. These factors, in part form the basis of a healthy worker effect, which has been used to explain the low mortality rates among workers exposed to ionizing radiation [89]. While the security clearance does not contribute to factors such as diet or exercise level, the background investigations and continual drug and alcohol screening reduce two common factors for ill health.

Changes in dosimetry technology over time present a significant challenge to the radiation epidemiologist. Though a quantitative analysis of the effects of dosimetry techniques on personnel dose records is beyond the present analysis, the predominant dosimetry technology used to develop the dose records is noted in each section. This work is intended to present the risks from external ionizing radiation. Though efforts were made to exclude any employee with a possible internal exposure, unreported internal exposures are possible and should be considered where relevant. The majority of the doses were recorded using film dosimeters (Los Alamos doses were only recorded in this manner). Those doses not recorded with film dosimeters were recorded using

thermo-luminescent dosimeters (TLDs). Removal of the TLD data was considered, but it was found that a significant fraction of the three study populations using TLDs in the 1970s and 80s had some dose recorded in this fashion, thus removal would have severely reduced the size of the data pool.

National and International scientific committees have been estimating the risks from the exposure of human beings to radiation for many decades and recommending models the assessment of radiation risk [37]¹⁴ [28] [90]. The risk estimates and models are largely based on studies of the Japanese atomic bomb survivors [91]. This data set provides a wealth of information about high-dose exposures, but little about low, chronic, doses as seen in an occupational setting. The typical methodology, however, is to perform a linear extrapolation from the high-dose range down to zero dose, where a risk value of zero is forced [90]. This is referred to as the linear, no-threshold model. As is discussed in both the ICRP and BEIR reports cited above, this model has been hotly debated over the last 40 years because of its disagreement with many toxicological and epidemiological studies of the effects of low-dose exposure data [37].

The results of the hypothesis testing developed in this work show that even for populations that are seemingly homogeneous in terms of socioeconomic status, statistically significant variations in the baseline cancer rates between each study are found. Thus, while risk estimates developed for Japanese atomic bomb survivors are very instructive about the effects of radiation on a large population of Japanese individuals, it is less useful as a tool to assess the risks of a small group of individuals who are unlikely

¹⁴ Though the ICRP does have other committees that suggest radiation dose limits, this report and the other two here cited only recommend models for assessing radiation risk at low doses. The ICRP was used as the basis to develop radiation protection recommendations made in ICRP 103 [1].

to have much in common with them genetically, culturally, or socioeconomically. Further uncertainty is introduced by the difference in dose rate seen by the A-bomb survivors as opposed to those seen by occupational radiation workers [90].

2.3 Methods

This work develops a method of combining epidemiological cohorts that serves as an alternative to aggregate pooling. It is applied to two different methods of assessing risk: regression and dose-bin averaging.

2.3.1 Risk Estimates

Internal comparisons of exposed healthy workers to unexposed healthy workers normalize the healthy worker effect, allowing for clearer examination of direct exposure effects. The data are treated as cohort studies and thus the effective measure is the relative risk (RR):

$$RR = \frac{P(\text{death} | \text{exposed})}{P(\text{death} | \text{unexposed})} = \frac{a/c}{b/d} \quad (1.10)$$

Where a is the number of cases of a biological endpoint (in the case of this study, death as the result of cancer) in the exposed group, b is the number of cases in the unexposed group, c is the number of exposed workers and d is the number of unexposed workers.

Using these quantities, a point estimate of the standard deviation of the natural logarithm of the relative risk can be found (based on a Taylor series approximation [92]) as [93]:

$$SD[\ln(RR)] = \sqrt{\frac{1}{a} + \frac{1}{b}} \quad (1.11)$$

Thus the variance is estimated by:

$$Var[\ln(RR)] = \frac{1}{a} + \frac{1}{b} \quad (1.12)$$

This research uses studies based on DOE workers (and contractors) exposed to ionizing radiation as the backdrop for the comparison of methods for weighting and combining the relative risk. The data is crude¹⁵ in the sense that there is no stratification according to socio-economic status, race, or education; it is assumed that within each study, the exposed and unexposed cohorts are similar with respect to these factors. The relative risks from each study are stratified by dose into bins containing roughly the same number of exposed individuals. The number and size of the dose bins chosen reflects the number beyond which, when the data were pooled, at least one bin had zero deaths. For dose-bin averaging, the same bin size was maintained for each study. For the regression analysis, the same number of bins was maintained though the size of the dose bin varied from study to study.

Regression

The linear model is given by:

$$\ln(RR) = b_{facility} \cdot Dose \quad , \quad (1.13)$$

where RR refers to the relative risk at each dose level and $b_{facility}$ is the regression or exposure-response parameter. This model is similar to the model used in Lubin and Boice Jr.'s meta-analysis of the risks associated with residential radon exposure [94], which was scaled to account for the baseline radon exposure of their control group. In the present case, the control group baseline is assumed to be zero and, as is shown in the hypothesis

¹⁵ "Crude data" is an epidemiological term implying lack of stratification in the data set. This data is not strictly crude in that it is stratified by dose.

testing section, homogeneous with the exposed group. This model will be fit to the data from each facility and then combined using the methods described below.

Dose-bin Averaging

Dose-bin averaging is a technique that stratifies the exposed populations from each facility into dose bins of a specific width in which the relative risk is calculated. Thus the relative risk is averaged over that dose bin. When using the methods described below as an alternative to pooling, the dose-bins can be calculated using the pooled data set to ensure an approximately equal number of exposed individuals in each bin.

Assessing Suitability of Data Sets for Pooled Analysis: Hypothesis Testing

Epidemiological data describing a biological endpoint, such as cancer death, can be described as a set of Bernoulli trials; thus, such data follows a binomial distribution [92]. The ratio of the number of observed cases of the endpoint to the total number of individuals in the study is treated as the binomial probability that the endpoint will occur. When this ratio is compared with the same ratio from another data set, a statistic, the z -score, describing the similarity of the two ratios can be calculated that follows a standard normal distribution. Comparing this z -score with its value in the standard normal distribution will result in the probability that the two ratios are identically distributed. This hypothesis can then be rejected (or not) at whatever confidence level the analyst desires. When the ratios from two epidemiological control groups are compared, the comparability of the two groups can be assessed; if the control groups are not similar, each cannot be directly compared to the other study's exposed group. Performing this type of hypothesis testing will provide a quantitative criterion for the decision to pool epidemiological data. Further, the results of the hypothesis testing will support the

philosophy that applying risk estimates that were calculated for one population to a culturally, racially, and geographically dissimilar population will likely result in misleading conclusions unless the dissimilarities are accounted for in some way. The unexposed populations were examined for homogeneity using a hypothesis test for the similarity of binomial ratios as follows.

Consider the null hypothesis:

$$H_0: p_{facility} = p_{pooled}$$

versus the alternative hypothesis:

$$H_1: p_{facility} \neq p_{pooled} .$$

The z-score tests statistic for the null hypothesis is [95]:

$$z\text{-score} = \frac{\hat{P}_{facility} - \hat{P}_{pooled}}{\sqrt{\hat{p}(1-\hat{p})\left(\frac{1}{n_{facility}} + \frac{1}{n_{pooled}}\right)}} , \quad (1.14)$$

where

$$\hat{p} = \frac{X_{facility} + X_{pooled}}{n_{facility} + n_{pooled}} \quad (1.15)$$

is the estimate of the common proportion under the null hypothesis and $X_{facility/pooled}$ and $n_{facility/pooled}$ are the number of observed cancer deaths and total population in either the facility or the pooled data set, respectively.

When combining cohort studies, if the unexposed groups are heterogeneous as determined by this hypothesis test, they should not be pooled. Rather, internally consistent estimates of the risk to the exposed group (such as the relative risk) should be calculated and then combined. In recent years, a significant body of literature on research synthesis, also called meta-analysis, has developed [96]. A meta-analysis is a quantitative literature review in which results of previously published studies can be combined to improve the statistical power of their conclusions. Perhaps the most common method for combining results, or effect sizes in the parlance, is to weight each study by the inverse of its variance [97] and take the weighted average of all studies. In situations where the risk estimates are not homogeneous between the studies, (analogous to combining mass measurements from different balances) the error must be characterized using a random effects model. The consequence is that, for data described by a random effects model, weighting the studies by the inverse of their variance requires applying a correction factor to the estimate of the variance [87]. Methods to achieve this have previously been developed for the combination of regression parameters [94] [87].

The new statistical methodology proposed in this study was applied to estimate the fatal cancer from occupational external radiation exposure averaged over stratified dose bins. This was achieved by calculating the relative risk of radiation exposure from radiation epidemiology data collected from four U.S. Department of Energy laboratories and combining them in the manner described below. This produces an estimate of fatal cancer risk that is specific to the populations studied. Data were gathered from the Comprehensive Epidemiological Data Resource [4] for four Department of Energy laboratories engaged in nuclear weapons research and development. These include, Los

Alamos National Laboratory [98], the Rocky Flats Nuclear Weapons Plant [99], the Hanford Site [100], and Oak Ridge National Laboratory [101]. Both dose-bin averaged and linear, no-threshold estimates were calculated. The preferred cancer-risk estimate in this situation is the relative risk, which compares the probability of death in the exposed group in a given cohort to the probability of death in the unexposed group in the same cohort, thus accounting for factors such as background radiation and other environmental confounders. Because the focus of this work is methodology, only mortality from all cancers was considered.

The combination method was based on meta-analytical techniques developed for the combination of results from randomized clinical trials. The concepts of homogeneity and heterogeneity in the context that follows differs from those relating to the homogeneity of studies discussed in the hypothesis testing section above. In this case, heterogeneity refers to a statistically significant effect produced by exposure to dose. In the previous context, heterogeneity refers to the makeup of a population, including socioeconomic status, geographic factors, racial distribution, and other latent factors that affect the results of the hypothesis testing.

2.3.2 Assessing Effect-Size Homogeneity: Fixed and Random Effects Models

Before the data sets can be combined, the homogeneity of the exposure-response parameters must be assessed. This will determine whether a fixed- or random-effects model¹⁶ is appropriate. In the following, $\beta_{i,j}$ represents the true effect size in study i and dose-bin j , and $\hat{b}_{i,j}$ represents the estimate of $\beta_{i,j}$ in study i and dose-bin j .

¹⁶ A fixed effects model, meaning that the systematic error is fixed, is analogous to taking many measurements on a single instrument (such as a balance). A random-effects model implies that the

Fixed-Effects Model

For a fixed-effects model, it is assumed that the exposure-response parameters from each study are normally distributed as¹⁷ $\hat{b}_{i,j} \sim N(\beta_{i,j}, 1/w_i)$, then

$\hat{b}_{i,j} w_{i,j} \sim N(\hat{b}_{i,j} w_{i,j}, w_i)$. Under the null hypothesis that $H_{0,i,j}: \beta_{i,j} = 0$ (implying no effect in each dose bin and each study) $\hat{b}_{i,j} w_{i,j}$ is distributed as $\hat{b}_{i,j} w_{i,j} \sim N(0, w_i)$. Under the combined null hypothesis, $H_0: \hat{b}_{1,j}, \dots, \hat{b}_{k,j} = 0$ it is found that

$$\sum_i \hat{b}_{i,j} w_{i,j} \sim N(0, \sum w_{i,j}) \quad (1.16)$$

Thus, the test statistic for each dose bin is:

$$U_j = \frac{\left(\sum_i \hat{b}_{i,j} w_{i,j} \right)^2}{\sum_i w_{i,j}} \quad (1.17)$$

follows a χ^2 distribution with one degree of freedom. In a meta-analysis, U can be used as a test statistic for H_0 . Assuming the homogeneity of treatment effects over all k studies in each dose bin, i.e., $\beta_{1,j} = \dots = \beta_{k,j} = \beta_j$, then,

$$\sum \hat{b}_{i,j} w_{i,j} \sim N\left(\beta_j \sum w_{i,j}, \sum w_{i,j}\right) \quad (1.18)$$

and the true summary statistic β_j can be estimated by \hat{b}_j given by:

systematic error is randomly distributed. This is analogous to taking one measurement on many different instruments that measure the same quantity.

¹⁷ In statistical notation, the tilde (\sim), denotes that a quantity follows a given distribution. Hence $X \sim N(0,1)$ should be read X follows a standard normal distribution with mean of 0 and variance of 1.

$$\hat{b}_j = \frac{\sum w_{i,j} \hat{b}_{i,j}}{\sum w_{i,j}} \quad (1.19)$$

Where \hat{b}_j is the weighted-regression parameter for dose bin j . The variance is given by:

$$\text{var}[\hat{b}_j] = \frac{\sum_i w_{i,j}^2 \text{var}(\hat{b}_{i,j})}{(\sum_i w_{i,j})^2} = \frac{\sum_i \left(\frac{w_{i,j}^2}{w_{i,j}} \right)}{(\sum_i w_{i,j})^2} = \frac{1}{\sum_i w_{i,j}} \quad (1.20)$$

Random-Effects Model

For a random-effects model, assume that the relative risk values calculated in each of the m dose bins from the raw data for each of the k studies ($b_{1,1} \dots b_{k,m}$) are an independent sample from a normal distribution (in each dose-bin across all studies) with mean β_j and variance τ_j^2 denoted as $\beta_{i,j} \sim N(\beta_j, \tau_j^2)$, and that each study- and dose-bin-specific estimate ($\hat{b}_{i,j}$) is normally distributed with mean $\beta_{i,j}$ and variance $1/w_{i,j}$, thus $\hat{b}_{i,j} \sim N(\beta_{i,j}, 1/w_{i,j})$. Because $\beta_{i,j}$ is normally distributed as $N(\beta_j, \tau_j^2)$, marginally, the estimate is distributed as $\hat{b}_{i,j} \sim N(\beta_j, 1/w_{i,j} + \tau_j^2)$. An estimator of the exposure-response parameter is given by:

$$\hat{b}_j^* = \frac{\sum_i w_{i,j}^* b_{i,j}}{\sum_i w_{i,j}^*}, \quad (1.21)$$

where $w_{i,j}^* = (w_{i,j}^{-1} + \hat{\tau}_j^2)^{-1}$ and the variance of the summary estimate \hat{b}_j is then

$$\text{var}[\hat{b}_j^*] = \frac{\sum_i (w_{i,j}^*)^2 \text{var}(\hat{b}_{i,j}^*)}{(\sum w_{i,j}^*)^2} = \frac{\sum_i \left(\frac{w_{i,j}^{*2}}{w_{i,j}^*} \right)}{(\sum w_{i,j}^*)^2} = \frac{1}{\sum w_{i,j}^*} = \frac{1}{\sum (w_{i,j}^{-1} + \hat{\tau}_j^2)} \quad (1.22)$$

The test statistic for homogeneity can be calculated as follows. The hypothesis test for homogeneity using the test statistic Q (which has an approximate χ^2 distribution with $K-1$ degrees of freedom under the null hypothesis of homogeneous log relative risks across studies) is a test of whether the variance of the of the estimators in each bin across all studies (τ_j^2) is equal to zero:

$$H_0 : \tau_j^2 = 0 \quad (1.23)$$

Should the estimate of τ_j^2 , denoted $\hat{\tau}_j^2$ be less than or equal to zero, a fixed-effect analysis is more appropriate because a zero or negative τ_j^2 occurs when $Q < K-1$ (which is the conditional expectation value of Q if $\tau_j^2 = 0$) implying that the studies are *not* homogenous. If $\tau_j^2 \geq 0$ a random effects model is appropriate. An estimate of τ_j^2 can be found as follows. The test statistic for homogeneity Q in each dose bin is given by a weighted sum of squares of the deviations:

$$Q_j = \sum_i w_{i,j} (\hat{b}_{i,j} - \hat{b}_j)^2 = \sum_i w_{i,j} (\hat{b}_{i,j} - \beta_j)^2 - \left(\sum_i w_{i,j} \right) (\hat{b}_j - \beta_j)^2 \quad (1.24)$$

so that:

$$E(Q_j) = \sum_i w_{i,j} \text{var}(\hat{b}_{i,j}) - \left(\sum_i w_{i,j} \right) \text{var}(\hat{b}_j) = \sum_i w_{i,j} (w_{i,j}^{-1} + \tau_j^2) - \left(\sum_i w_{i,j} \right) \left\{ \frac{1}{\sum_i w_{i,j}} + \frac{\tau_j^2 \sum_i w_{i,j}^2}{\left(\sum_i w_{i,j} \right)^2} \right\}, \quad (1.25)$$

which simplifies to

$$E(Q) = (k-1) + \tau_j^2 \left(\sum_i w_{i,j} - \frac{\sum_i w_{i,j}^2}{\sum_i w_{i,j}} \right). \quad (1.26)$$

Rearranging, it is found:

$$\tau_j^2 = \frac{E(Q) - (K-1)}{\sum_i w_{i,j} - \frac{\left(\sum_i w_{i,j}^2 \right)}{\sum_i w_{i,j}}} \quad (1.27)$$

Because the expected value is the first sample moment [102], the moments-method estimator of τ_j^2 , denoted $\hat{\tau}_j^2$ is given by:

$$\hat{\tau}_j^2 = \frac{Q - (K-1)}{\sum_i w_{i,j} - \frac{\left(\sum_i w_{i,j}^2 \right)}{\sum_i w_{i,j}}} \quad (1.28)$$

2.3.3 Data Sets

Four groups and respective control groups were selected from the CEDR database for combination; Los Alamos National Laboratory [98], the Rocky Flats Plant [99], the Hanford Site [100], and Oak Ridge National Laboratory [101]. The data presented here omits workers with reported internal exposure. Given the changes in dosimetry models over the years, comparing data over the span of 30 years or more could be considered suspect. In general, however, it has been judged that the recorded doses in these studies

were a “reasonable” estimate of the deep dose (1 cm) [103] [53]. In this study, the relative risk is the preferred risk estimator. Because this quantity compares the exposed population to the unexposed population at the same site (Los Alamos, Rocky Flats, etc.), natural exposure to background radiation can be excluded from the analysis as both the exposed and unexposed are likely to experience, on average, the same background dose rate and accumulation.

Each of these studies presents its own inherent uncertainties. By returning to the raw data, considering only external dosimetry and by using the relative risk metric, attempts have been made in this study to minimize some of these uncertainties (changes in dosimetry models healthy worker effect, etc.). However, factors such as chemical exposure and uncertainty in the dosimetry measurements were not considered (primarily because of lack of information), though they could affect the results. In all cases, gender, ethnicity, and change in dosimetry technology or modeling are not considered.

A summary of relevant information about each data set is presented in Table 6 including, for each data set, total number of workers involved in each data set, number of workers exposed and unexposed, exposure period and length of follow-up period.

Table 6. Cohort details for each of the four studies considered in this work.

	Total # of Workers	Exposed	Unexposed	Exposure Period	Length of Follow up (years)
LANL	6,168	2,368	3,800	1943-1977	50
Rocky	9,490	4,489	5,001	1951-1989	41
Hanford	26,013	23,659	2,354	1944-1978	50
ORNL	15,185	10,783	4,402	1944-1982	40

In the section describing each data set, a histogram is presented showing the frequency distribution for doses in the highest dose bin. This is presented because the highest dose bin is also the widest in terms of its edges. Further, for each data set, the doses in this bin are highly skewed and in many cases, the maximum dose is a relative outlier.

Considerable effort was made by the original authors of each study to choose control groups that closely approximated the exposed population in race, age, and socioeconomic status. Details about control group selection are found in the published studies based on these references. Sources of uncertainty in dosimetry are presented where available. A more thorough treatment of these errors and their implications for risk assessment are found in the peer-reviewed studies based on the data sets used in this work. The fraction of unexposed workers who died of fatal cancer for each facility (and pooled) is shown in Table 7.

Table 7. Fraction of fatal cancers among unexposed workers at various facilities.

Facility	LANL	Rocky	Hanford	ORNL	Pooled
Fatal Cancer Fraction	0.0707	0.0338	0.0930	0.0657	0.060102

Los Alamos Data Set

The first data set was from a study of workers at Los Alamos National Laboratory [98]. The study for which this data was originally intended was designed as a cohort study for examining health detriment in workers with internal exposures to plutonium as compared to unexposed workers and those exposed only to external ionizing radiation. Film dosimeters were used for the majority of personnel monitoring from 1944 through the end of 1979 (after the last exposure considered), when they were replaced with

thermoluminescent dosimeters (TLDs). Formal bioassay programs to monitor for internal exposures were begun in 1944. Both external and internal radiation exposure data were available for all members of the study.

For use in the present work, workers with measurable amounts of internal radionuclide deposition were omitted from this and all other datasets. If workers had the potential for internal contamination by radionuclides (as reported in the published data set), but had body burdens too low to measure, they were excluded from the data set.

Figure 5 shows a stair plot of the relative risk stratified into eight equal-percentage dose bins for the Los Alamos data (henceforth dose-binned relative risks). In all cases, the variance is estimated by equation (1.12). In the context of the relative risk estimates, the “variance” column in the following tables refers to the variance of the relative risk estimate in each dose bin.

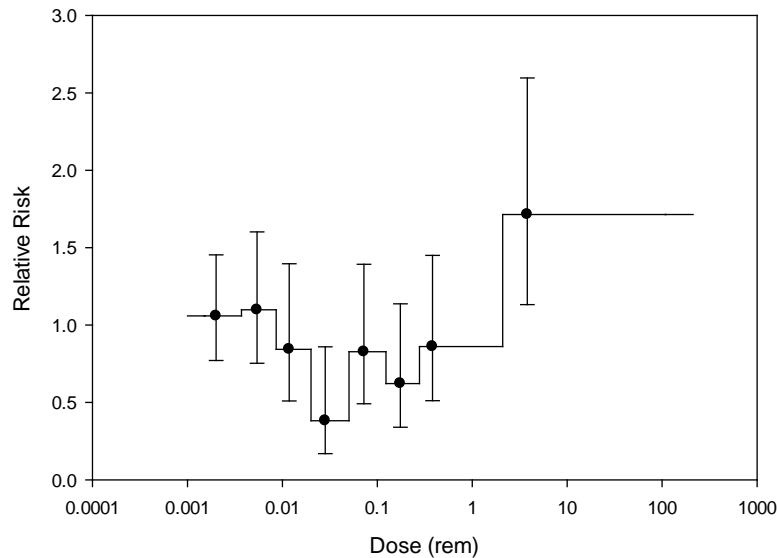

Figure 5. Stair plot of the relative risks for the Los Alamos National Laboratory data set stratified into eight dose bins.

Table 8 representing the details of the Los Alamos Data set. Further, a histogram showing the frequency distribution of doses in the highest bin is presented in

Table 8. Details of Los Alamos Data Set

Maximum Dose (rem)	Died	Total Exposed	Relative Risk	95% Confidence Interval	
				0.025	0.975
0.03	41	547	1.059	0.7709	1.4543
0.07	29	373	1.098	0.7527	1.6026
0.17	16	268	0.843	0.5093	1.3966
0.41	6	222	0.382	0.1697	0.8590
1.08	15	256	0.828	0.4918	1.3932
2.52	11	250	0.622	0.3398	1.1369
5.31	15	246	0.861	0.5115	1.4507
109.11	25	206	1.714	1.1320	2.5964

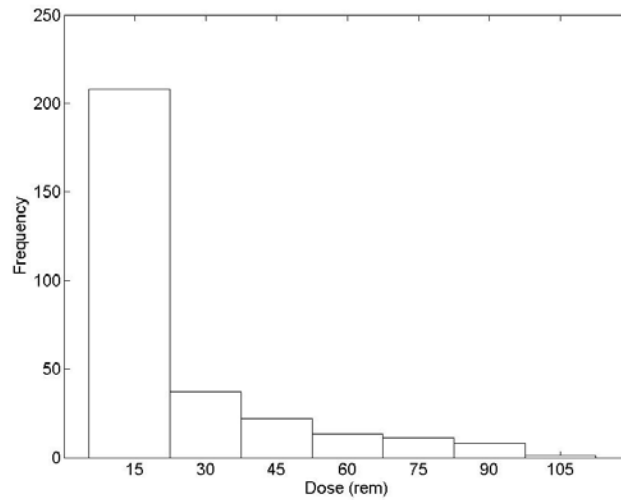

Figure 6. Frequency distribution of doses in highest dose bin for Los Alamos data set.

Hanford Data Set

The second dataset represented workers from the Hanford site [100], and was the largest study. Being the largest dataset considered, the Hanford results have the most

complete dose spectrum. The primary exposure agents were tritium, plutonium, americium, cesium, curium, europium, promethium, and strontium. A stair plot of the dose-binned relative risks is shown in Figure 7. Dose records were collected using film badges and, in the 1970s, TLDs [103].

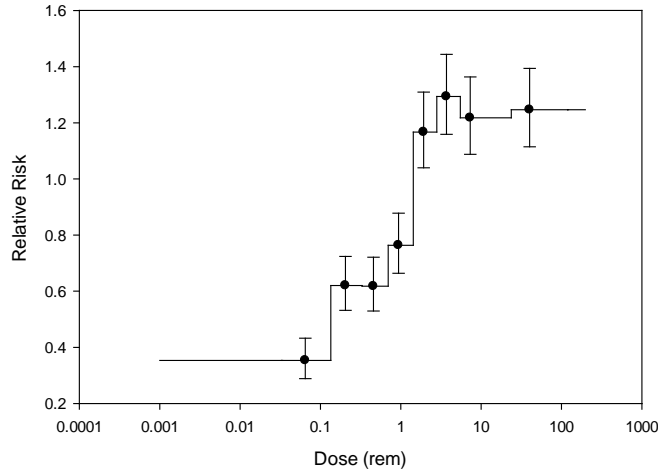

Figure 7. Histogram of the relative risks for the Hanford site data set stratified into eight dose bins.

Details of the Hanford data set are shown in Table 9. A histogram of the frequency distribution of doses in the highest (and widest) bin is shown in Figure 8.

Table 9. Details of Hanford Data Set

Maximum Dose (rem)	Died	Total Exposed	Relative Risk	95% Confidence Interval	
				0.025	0.975
0.12	97	2951	0.35	0.2886	0.4325
0.30	171	2963	0.62	0.5317	0.7237
0.65	170	2958	0.62	0.5293	0.7210
1.33	210	2957	0.76	0.6637	0.8780
2.67	321	2957	1.17	1.0399	1.3093
4.87	356	2958	1.29	1.1589	1.4440
11.52	335	2957	1.22	1.0876	1.3634
197.75	343	2958	1.25	1.1146	1.3938

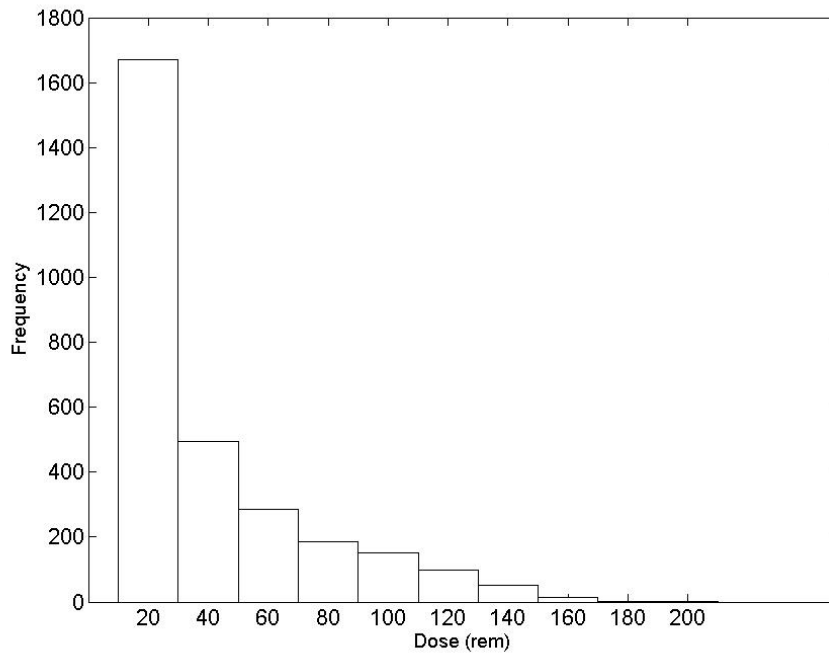

Figure 8. Frequency distribution for doses in the Hanford data set.

Rocky Flats Data Set

The third dataset is from the Rocky Flats Plant [99]. A stair plot of the dose-binned relative risks is shown in Figure 9. Chemical exposure data, also from CEDR shows that workers were exposed to significant levels of known carcinogens such as carbon tetrachloride (CCl_4) [104]. The levels at which the workers were exposed to carcinogens and their associated risks were not considered quantitatively in the present study. Doses were recorded using film badges through 1970 when they were replaced by TLDs [105].

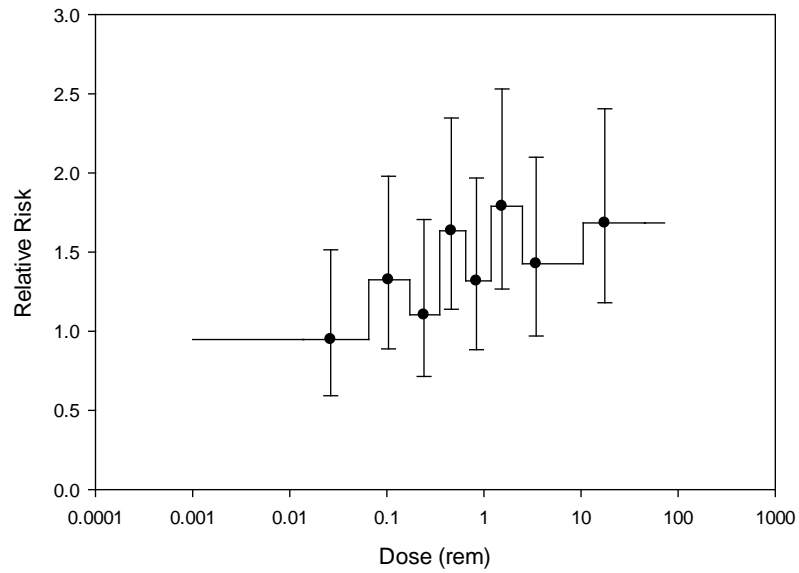

Figure 9. Histogram of the relative risks for the Rocky Flats data set stratified into eight dose bins.

Details of the Rocky Data set are shown in Table 10 . Figure 9 shows the frequency distribution of doses in the highest (and widest) bin.

Table 10. Details of the Rocky Flats Plant Data Set

Maximum Dose (rem)	Died	Total Exposed	Relative Risk	95% Confidence Interval	
				0.025	0.975
0.057	18	562	0.948	0.5928	1.5154
0.164	25	558	1.326	0.8881	1.9792
0.333	21	563	1.104	0.7140	1.7063
0.619	31	561	1.635	1.1390	2.3476
1.097	25	561	1.319	0.8834	1.9685
2.093	34	562	1.790	1.2664	2.5307
5.474	27	560	1.427	0.9697	2.0992
72.486	32	562	1.685	1.1800	2.4059

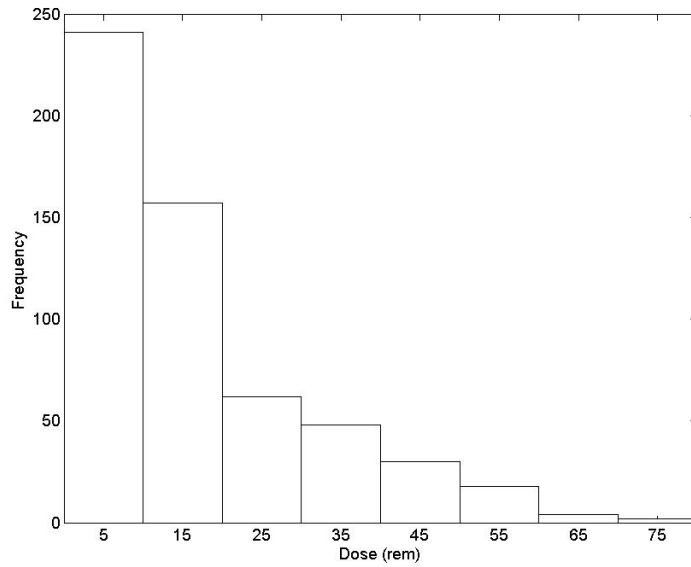

Figure 10. Histogram of the frequency distribution of doses in the highest bin for the Rocky Flats data set.

Oak Ridge National Laboratory Data Set

The final dataset included in this analysis is based on workers at Oak Ridge National Laboratory (ORNL) at the K-25, X-10, and Y-12 sites [101]. The primary exposure agents were uranium and fission products. The workers considered in this study were also exposed to known carcinogens such as asbestos as well as lead, beryllium, and organic solvents, though exposure levels are not presented along with the data and risks because they are not considered in this study. Regarding errors in dose records, this study found an upward bias in dose-response coefficients and likelihood ratio test statistics. However, this study only considered missing dose records and did not consider measurement and other dosimetry errors. For exposures between 1944 and 1980, doses

were recorded by film badges. In 1980, film badges were replaced with TLDs [106]. A stair plot of the relative risks in this data set are shown in Figure 11.

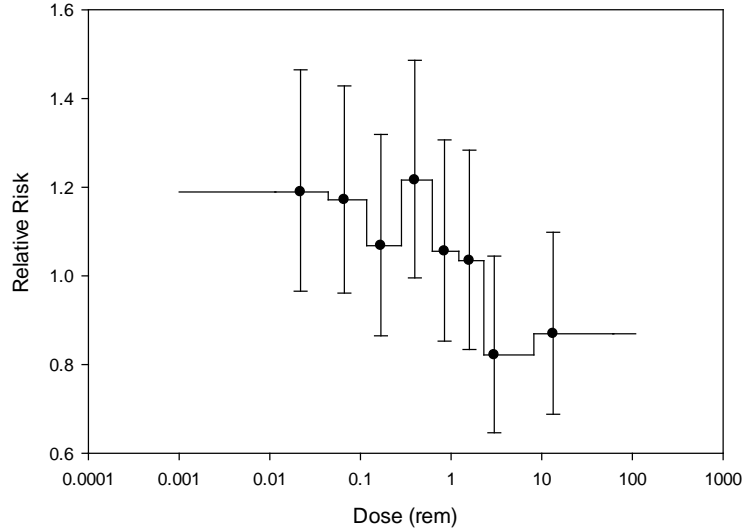

Figure 11. Histogram of the relative risks for the Oak ridge National Laboratory data set stratified into eight dose bins.

Details of the Oak Ridge data set are shown in Table 11. A histogram showing the frequency distribution in the highest (and widest) dose bin is shown in Figure 12.

Table 11. Details of Oak Ridge Data Set

Maximum Dose (rem)	Died	Total Exposed	Relative Risk	95% Confidence Interval	
				0.025	0.975
0.039	95	1265	1.19	1.4648	0.9654
0.109	105	1419	1.17	1.4286	0.9610
0.25	92	1364	1.07	1.3191	0.8648
0.583	103	1341	1.22	1.4861	0.9954
1.155	90	1350	1.06	1.3067	0.8528
2.116	88	1347	1.03	1.2834	0.8338
4.461	70	1349	0.82	1.0448	0.6462
108.555	74	1348	0.87	1.0984	0.6879

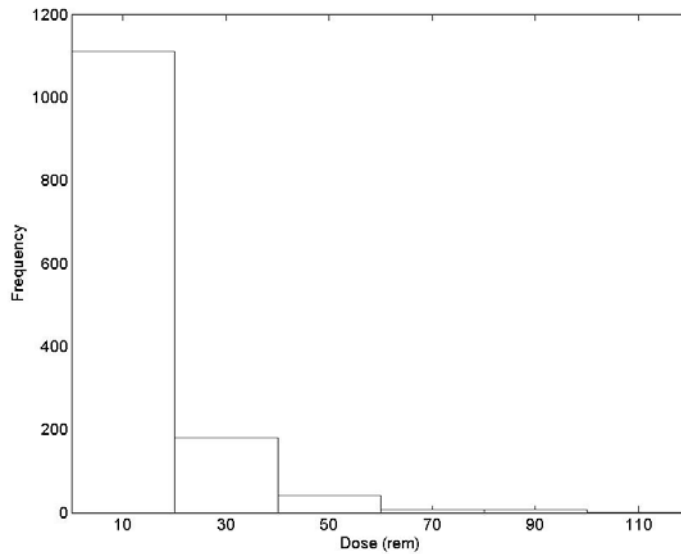

Figure 12. Histogram of the frequency distribution of doses in the highest dose bin in the Oak Ridge National Laboratory Data set.

2.4 Results

2.4.1 Evaluation of Facility Homogeneity

Comparison of each facility with the pooled population

The results of the hypothesis testing for comparing each facility's unexposed population and the pooled unexposed population demonstrates that the null hypotheses that the Los Alamos, Rocky Flats and Hanford populations are identically distributed with the pooled unexposed population can be rejected above the $p = 0.05$ level. For the Oak Ridge data set, this null hypothesis cannot be rejected at this level. The results are shown in Table 12. This result implies that, when pooled, the unexposed population from all facilities does not accurately describe the unexposed populations from three of the facilities. Thus, there are latent factors in each population that will bias the outcome of the pooled analysis and the data sets should not be combined using this method.

Table 12. Results of hypothesis tests to determine homogeneity between the individual control groups and pooled control groups.

Facility	\hat{p}	Common Proportion	z-score	p-value
Los Alamos	0.071	0.071	2.446	0.0200
Rocky Flats	0.034	0.058	-7.179	2.56×10^{-12}
Hanford	0.093	0.069	6.065	4.11×10^{-9}
Oak Ridge	0.063	0.065	0.7482	0.302

Homogeneity Between Each Facility

Hypothesis testing of the four data sets described above has found that, while the null hypothesis that Los Alamos and Oak Ridge unexposed data sets are identically distributed cannot be rejected (at the $p = 0.05$ level), the same null hypothesis for every other combination of studies can be rejected. Thus, when calculating relative risks, no unexposed population among these facilities is suitable for use as a baseline against which to calculate relative risk for all the populations, separately or pooled. Each facility must be compared against its own unexposed populations. The results of these hypothesis tests are shown in Table 13.

Table 13. Results of hypothesis testing comparing the unexposed populations between facilities.

Facility Combination	Common Proportion	z-score	p-value
Los Alamos- Rocky Flats	0.0498	7.905	1.07E-14
Los Alamos –Hanford	0.0793	-3.139	0.0029
Los Alamos –Oak Ridge	0.0793	1.382	0.1535
Rocky Flats- Hanford	0.0528	-10.6	1.56E-25
Rocky Flats- Oak Ridge	0.0475	-6.676	8.36E-11
Hanford – Oak Ridge	0.0736	4.483	1.73E-05

2.4.2 Regression Analysis - Linear, No Threshold Model

The relative risks for each study have been calculated separately, and generalized linear regression was performed on each. The regression parameters were combined using a method similar to that described above, but for only one “j” bin. These results are plotted in Figure 13.

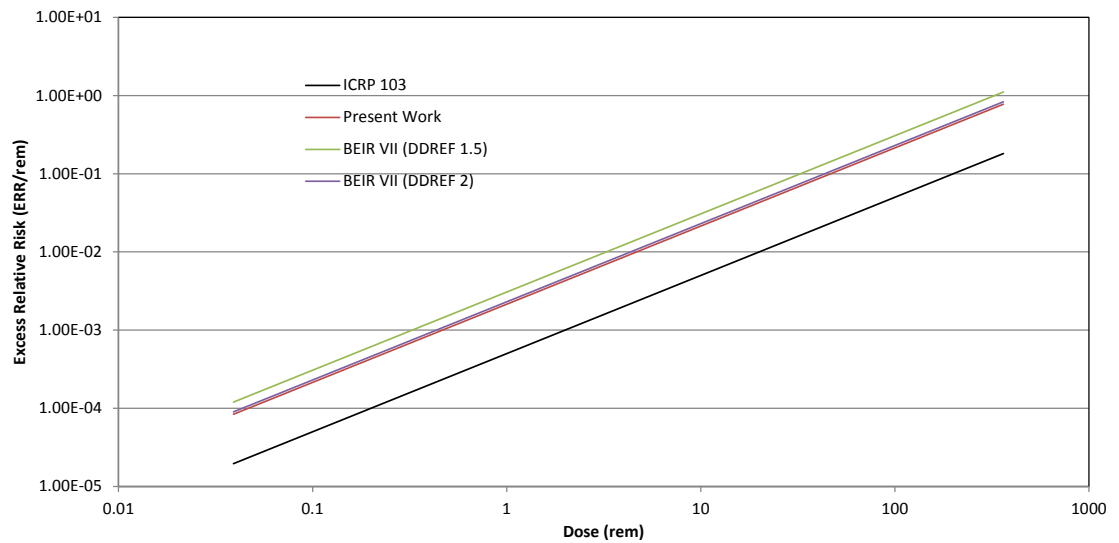

Figure 13. Comparison of linear, no-threshold estimates of risk. The summary estimate developed by this work nearly overlaps with the BEIR VII estimate which takes a DDREF of 2.

The risk in ERR/rem using the method developed in this paper is compared with that developed by other committees in Table 14:

Table 14. Excess Relative Risk (ERR) per rem for each study

	Present Work	ICRP-103	BEIR-VII (DDREF of 1.5)	BEIR-VII (DDREF of 2)
Estimate (ERR/rem)	2.14×10^{-3} with 95% CI (-0.0145 , 0.0188	5.0×10^{-4}	2.51×10^{-3}	1.83×10^{-3}

Several assumptions were necessary in calculating the BEIR VII linear risk estimates. The BEIR VII committee calculates relative risk for each sex and adjusts it based on age at first exposure (up to 30) and attained age (up to 60). This work assumed that all exposures occurred at or after the age of 30 and that the risk was estimated for workers above 60. Further, the proportion of each sex of the exposed population was assessed and then a weighted average was calculated, as shown in Table 15.

Using these fractions to weight the male and female contributions to relative risk (0.23 and 0.47 ERR/Sv, respectively) provides the BEIR VII estimates that were shown in Table 14. These BEIR VII risks are for solid cancers; the BEIR VII leukemia model is linear-quadratic and only applies to the 5-year period after the exposure.

Table 15. Sex distribution of workers exposed to external ionizing radiation in the four studies examined in this work.

Facility	Male Fraction	Female Fraction	Study Size weight
Los Alamos	1.0	0	0.06
Hanford	0.71	0.29	0.57
Rocky Flats	0.89	0.11	0.11
ORNL	0.46	0.54	0.26
TOTAL	0.68	0.32	

The ICRP-103 estimate of ERR/Sv was calculated from Tables A.4.1, A.4.11 and A.4.12 in the report. This alternate calculation was done because the commission's preferred estimate, the "detriment adjusted nominal risk coefficient" is not an appropriate quantity with which to compare the Excess Relative Risk. The ICRP's ERR/Sv value reported in Table 14 is sex-averaged and includes leukemia mortality. The differences between the ICRP estimate and the BEIR-VII estimate highlight the uncertainties inherent in the use of a dose and dose-rate effectiveness factor.

2.4.3 Dose Bin Averaging

The new method developed in this work of combining dose-bin averaged risks using the meta-analytical techniques described above was applied to the bin-averaged relative risks from each facility. The dose-bin averaged all-cancer mortality relative risks developed using the new method are plotted in Figure 14.

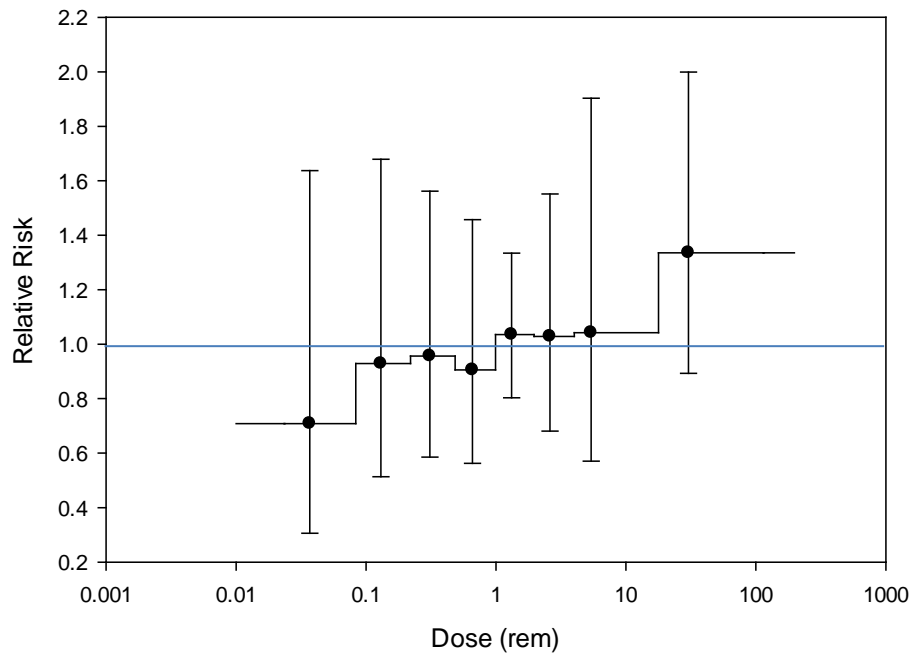

Figure 14. Relative risks from Los Alamos National Laboratory, Oak Ridge National Laboratory, the Rocky Flats Plant and the Hanford Site combined using the method developed in this work. Error bars represent 95% confidence intervals.

The risks are also presented in Table 16. The mean risk predicted for cumulative exposures below about 1 rem show a prophylactic effect in these populations. However, the 95% confidence interval contains the zero-equivalency point (RR=1) at all doses.

There is a large jump in the highest energy bin; this is possibly due to dose-rate effects in individuals receiving higher doses.

Table 16. Relative risks from Los Alamos National Laboratory, Oak Ridge National Laboratory, the Rocky Flats Plant and the Hanford Site combined using the method developed in this work. Error bars represent 95% confidence intervals.

Dose (rem)	Relative Risk	95% Confidence Interval	
		0.025	0.975
0.074	0.71	0.306	1.638
0.2	0.93	0.514	1.679
0.45	0.96	0.585	1.562
0.92	0.91	0.562	1.457
1.82	1.04	0.803	1.335
3.63	1.03	0.681	1.552
8.24	1.04	0.571	1.903
197.8	1.34	0.893	1.999

For comparison, relative risks were also calculated using the method of data pooling; these results are shown in Figure 15. (Tabulated results are presented in Table 17). Comparing these two figures, it is clear that the technique of pooling over-estimates the risks to workers. Thus, the utility of the new method using meta-analysis techniques is demonstrated. The control population for the pooled estimate was the pooled unexposed population drawn from all studies. Data was pooled (and confidence intervals calculated) using the open source epidemiological tool Openepi [107].

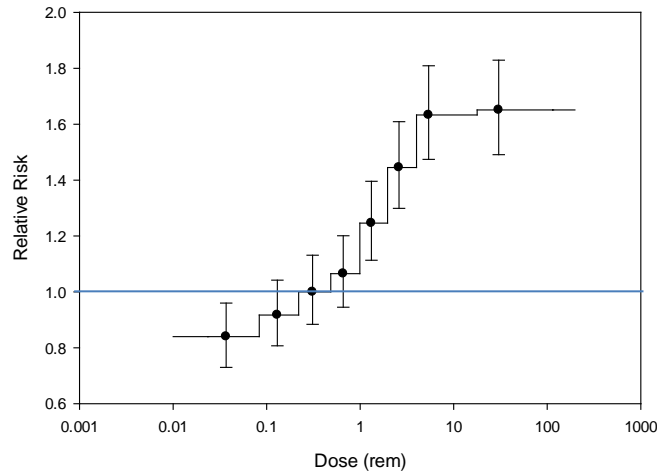

Figure 15. Relative risks calculated from pooled (Aggregated) data from all four studies.

Table 17. Relative risks from Los Alamos National Laboratory, Oak Ridge National Laboratory, the Rocky Flats Plant and the Hanford Site combined using the obsolescent method of Data Pooling. Error bars represent 95% confidence intervals.

Dose (rem)	Relative Risk	95% Confidence Interval	
		0.025	0.975
0.074	0.84	0.730	0.960
0.2	0.917	0.807	1.042
0.45	1.000	0.884	1.131
0.92	1.065	0.945	1.201
1.82	1.246	1.113	1.396
3.63	1.445	1.299	1.609
8.24	1.633	1.474	1.809
197.8	1.651	1.491	1.829

The highest-dose bin is also the widest. Thus, a histogram is presented demonstrating the frequency distribution of doses in this highest bin. As expected the doses are skewed toward the lower edge of the bin. The lowest bin is cut off at 1,000 for illustration purposes though it represents 3,587 data points.

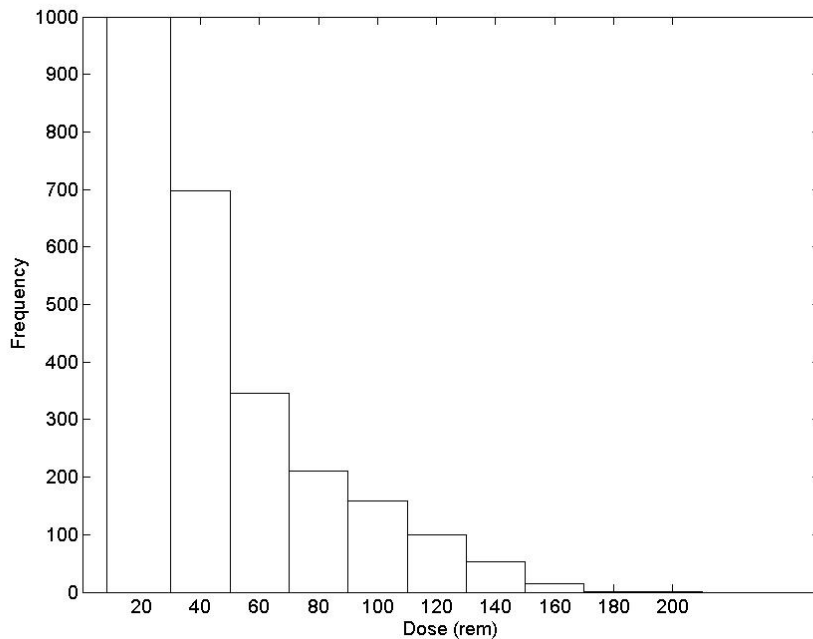

Figure 16. Histogram showing frequency of doses in the highest dose bin for the pooled data set. Abscissa labels are at bin midpoints. Lowest dose bin contains 3,587 doses that are cut off for ease of display.

2.5 Chapter Conclusions

This chapter developed a new framework for evaluating the occupational risks seen by workers, not only in radiation environments, but in any setting where ALARA practices are mandated. This framework was achieved by first developing a method for determining the homogeneity of epidemiological study populations and showing that heterogeneous populations are not suitable for pooled analysis. This work then proposed a new statistical methodology, based on the techniques of meta-analysis, which provides an alternative method of combining epidemiological studies that avoids the pitfalls of pooling.

The cohort-combination methods developed in this work were used to develop all-cancer mortality risk estimates for department of energy workers employed at four nuclear weapons laboratories: Los Alamos National Laboratory, Oak Ridge National Laboratory, the Rocky Flats Plant, and the Hanford Site. The methods developed in this work were used to estimate risks to these workers in two ways: the combination of regression parameters and the combination of dose-bin averaged risks. The linear regression methodology showed excellent agreement with previously published estimates derived from studies of the atomic bomb survivors. This parameterization of excess relative risks, however, forced the assumption of a linear, no-threshold model which, as was seen in the dose-bin averaged data, was not necessarily appropriate for the data set.

The dose-bin averaged data suggests that below a lifetime dose of 1-rem, exposure to radiation may provide a prophylactic effect, known as hormesis. This is a common finding in the literature and is often attributed to the “healthy worker effect.” By choice of the relative risk as the dose-response metric, however, the healthy worker effect is expected to be normalized as healthy workers are compared to other healthy workers. Further, by requiring tests of heterogeneity before cohorts are combined, the healthy worker effect is further minimized.

It is clear from a comparison of Figure 14 with Figure 15 that the risk estimates derived from the pooled analysis overestimate those derived from the technique developed by this work. Thus, previous studies that employed pooled analysis should be revisited, their populations evaluated for heterogeneity, and possibly recombined to determine the degree to which the original results were subject to a cohort-heterogeneity bias.

Chapter 3. Application of Risk Estimates to ALARA assessment of the Americium Recovery Project

3.1 Introduction

This research develops a dose assessment for the processes required to fulfill the production planning basis for the proposed Americium Recovery Project (ARP) to recover americium-241 from americium-rich plutonium residues. This research also develops a methodology for assessing whether current staffing plans result in worker doses that are as low as reasonably achievable (ALARA), given the shielding and radiation protection scheme here developed. This work evaluates the risk associated with the radiation protection scheme in terms of the linear no-threshold estimate of risk developed in the previous section, and compares the risk to Los Alamos' current definition of acceptable. In addition to modifying existing MCNP5 glovebox models, this research also develops several new models for various shielding designs. Further, time and motion data for these processes are developed to estimate the total dose to workers engaged in these operations. The goal of this research is a new dose analysis for the Americium Project based on the best available information plus a determination of the number of workers required to keep doses below an acceptable level given different dose-response paradigms. This latter goal serves to implement some of the models and results from Chapter 2 toward development of a new activity at Los Alamos. The time-motion study and glovebox model used by this work are both being implemented by the radiation protection analysts employed by the ARP.

3.2 Background

There is a continuing national need for americium-241 (Am-241, ^{241}Am) to support fabrication of Americium-Beryllium (AmBe) neutron sources, the largest customer for which is oil and natural gas well-logging companies [108]. Overall, there is

a dearth of Am-241 supply and there are many customers who are interested in obtaining these sources. Am-241 feed sources are varied, but the most common and easily extractable sources are those in plutonium-based materials. Historically, the Department of Energy supplied the actinide alpha-emitting material, usually AmO₂ that was then mixed with beryllium to create a neutron source [109]. Given the current lack of supply, there is renewed interest in supplying Am-241 to commercial interests.

Am-241 extracted by the ARP will primarily be used in well-logging applications. Well-logging is a critical process in the assessment of the production potential of a well; in fact, most financial institutions only accept data derived from AmBe sources. The DOE supports the oil and gas industry in many ways to help ensure the overall security of the petroleum supply. The Rocky Flats Plant and Hanford produced Am-241 in the 1960s and 1970s which was primarily extracted from weapons-grade plutonium. In the early 1980s, Los Alamos and the Savannah River Site produced 14 kg AmO₂, which resulted in a glut in the americium market leading to the cessation of the DOE americium program. This supply has been depleted and currently companies are purchasing americium sources from Russia. To mitigate americium market volatility and supplier risk, the DOE in concert with industrial partners has identified a need for a sustainable domestic production supply [109]. The Los Alamos Plutonium Facility, PF-4, has been chosen to extract the Am-241 from plutonium. Most of the americium would be obtained from spent salt residues that were or are produced during molten-salt extraction (MSE) or in-situ chlorination operations, both of which are used to extract americium from plutonium to provide plutonium feed to other programs like Pit Manufacturing. The MSE salts, which still contain significant quantities of plutonium, are processed through chloride-

based aqueous chemical recovery to recover the plutonium. An additional process added to chloride recovery would allow the americium in these salts to be purified as an oxide. The anticipated batch size would be an output of 30 g AmO₂ per batch.

The primary radiological concern with weapons-grade plutonium or concentrated sources of Am-241 is photon exposure. Am-241 is a decay product from Pu-241, which is produced by successive neutron capture in lower atomic mass number plutonium nuclides as they are irradiated in reactors. In higher grades of plutonium, e.g., weapons-grade plutonium, the Pu-241 is a normal, yet minor, isotopic component of the plutonium. Pu-241, with a half-life of 14.4 years, beta decays to Am-241, which has a longer half-life of 432.7 years. Thus, the Am-241 net ingrowth is relatively rapid because it builds up faster than it decays. The pertinent decay chain is shown in Equation (2.1).

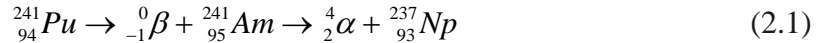

The key exposure concern with this decay chain is that, as the excited Np-237 nucleus transitions to its ground state, it produces a relatively intense (high yield) 59.5 keV gamma ray. This low-energy gamma ray is relatively easy to shield with appropriate technology such as glove boxes with lead- or composite-lined gloves and leaded glass viewing windows.

A Staffing Problem

Given the radiological concerns with processing MSE residues and, more specifically, Am-241, an exposure assessment must be performed to assess the dose to the workers who will be performing the process steps. Because the process has been fully

designed, it is possible to perform this assessment in accordance with the planning basis of 25 batches of AmO₂ per year [109].

The federally- (and locally-) mandated radiation-protection design objective for new processes at Los Alamos is that the dose rates (including background doses from other processes in the room) not exceed an average of 0.5 mrem/h (resulting in 1 rem/year for a 2,000-hour work year). This poses a significant problem because the area in which the americium gloveboxes are to be located has a background dose rate of, on average, greater than 1 mrem/h.

Further, there is not sufficient time in a year for one worker to complete 25 production cycles. If each cycle takes about 94 hours, one worker would require about 2,346 hours (about 59 40-hour weeks) to complete 25 cycles. A study of worker efficiency at Los Alamos national Laboratory suggests that workers are 42% efficient [110] (after accounting for holidays, vacation, dressing out,¹⁸ etc.) a single worker has 840 productive hours per 2,000 hour year (2,000 · 0.42 = 840). Thus, the minimum number of employees that are required strictly to fulfill the planning basis is:

$$\frac{2345.5 \frac{\text{hours}}{\text{year}}}{840 \frac{\text{hours}}{\text{employee} - \text{year}}} = 2.79 \text{ employees} \quad (2.2)$$

Thus it is necessary to have multiple workers engaged in americium activities based on processing requirements alone. After calculating the dose to a single (notional) individual performing 25 operations per year, this dose can then be divided among

¹⁸ The term “dressing out” refers to applying the appropriate personal protective equipment (PPE) required to enter a radiation controlled area.

multiple workers to satisfy federal and local dose-limit regulations and requirements. The DOE mandates in 10 CFR 835 that doses be kept “As Low As Reasonably Achievable” (ALARA) [111]. From the perspective of Los Alamos, ALARA translates to capital expenditures of \$2000 per person-rem avoided and up to \$10,000 per person-rem avoided for employees exceeding 1 rem [19].

The question this analysis addresses is how to determine the optimal number of employees to use considering the change in risk that each will incur as the work is spread among an increasing number of employees. First, the ALARA-reasonable staffing requirements will be calculated by comparing the change in cost per employee added with the monetary savings that spreading the dose among n employees would affect because of decreased need for ALARA expenditures.¹⁹

An alternative method of developing a risk-based estimate of the optimal number of workers is to compare the change in risk each worker experiences as the dose is spread among a larger population to the marginal cost of hiring additional workers. This method determines what the fair value of the worker’s risk is by equating it with their agreed-upon compensation. Compensation does not simply refer to the amount that the worker is paid, but the burdened cost to the program employing the worker. Acceptance of employment by the program is tantamount to the worker’s belief that the institution is being fairly charged for the risk the worker is incurring. As the individual’s risk is decreased, so is their cost, presumably. The value at which the cost equals the risk is the optimal value.

¹⁹ 2,000 per person-rem avoided and \$10,000 per person-rem avoided for individuals nearing their administrative limit.

A third method compares the change in risk to the workers as more workers are added to the “reasonable” ALARA expenditures to estimate the number of employees necessary to maintain the risk to any individual below an acceptable level.

3.3 Methods

This section details the methods, both conceptual and computational, to determine an estimate for the minimum number of workers necessary to maintain americium project workers’ risks below acceptable levels.

3.3.1 Radiation Transport Calculations

Particle transport theory is the study and development of solutions to variants of the Boltzmann transport equation for kinetic gases. While there are several common numerical methods used to directly solve the equation, one of the most popular techniques of transport theory, the Monte Carlo method, indirectly approximates a solution. The Monte Carlo method is a stochastic numerical technique that exploits the fact that macroscopic cross sections may be interpreted as a probability of interaction per unit distance traveled by a particle. A set of particle histories is generated by following individual particles through successive collisions. These collisions and their results are determined from the range of possibilities by sets of random numbers. Perhaps the most well-known code based on this method is the Monte Carlo N-Particle transport code (MCNP version 5, or MCNP5). All transport calculations performed for this analysis, namely those to estimate the neutron and gamma-ray doses, will use MCNP5.

Photon and Neutron Source Terms

The photon and neutron source terms used in this analysis were calculated using ORIGEN-ARP. The photon source term (in photons per second per gram) for 1 gram of pure americium-241 is shown in Figure 17.

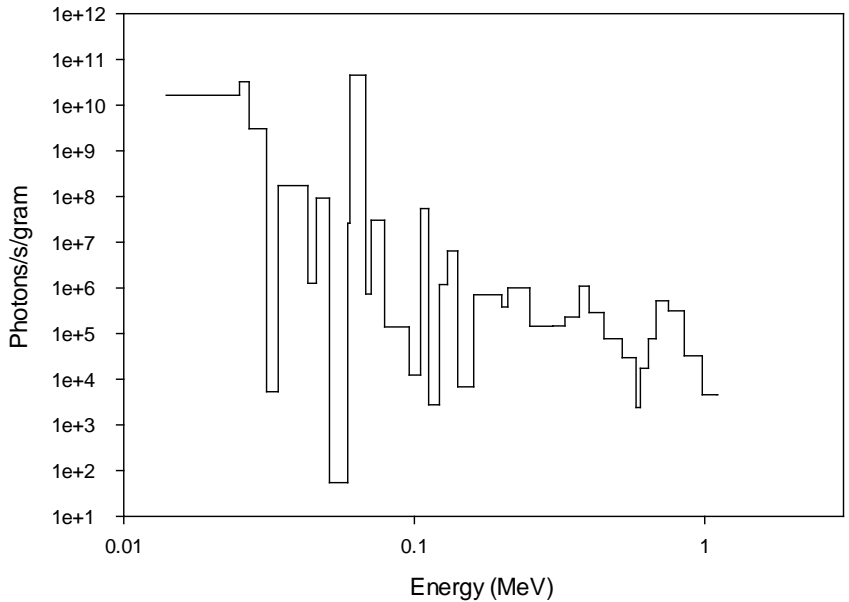

Figure 17. Photon spectrum for Americium-241 source material.

The neutron source term is due to alpha-n reactions in the americium oxalate and oxide forms. Plots of these neutron spectra are shown in Figure 18.

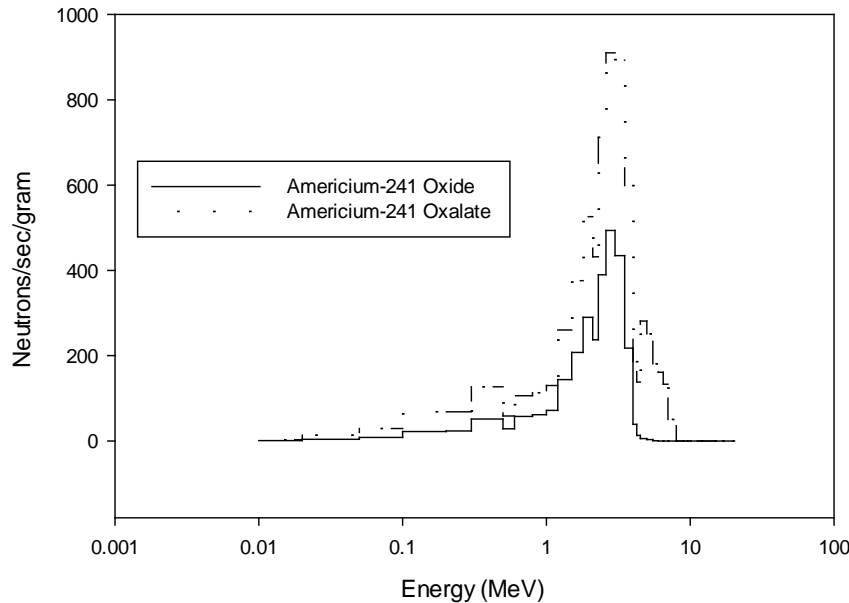

Figure 18. Neutron spectrum for americium-241 oxide and oxalate.

Glovebox Models

The first step of this analysis was the development of computational models of the planned gloveboxes and the sources contained therein. The configurations and shielding technologies present in various gloveboxes vary from application to application. Four gloveboxes were selected for analysis. The first glovebox (glovebox 1) would house the primary plutonium processing unit operation that extracts the majority of the americium from the feed stock. The second glovebox (glovebox 2) would house two processes: secondary plutonium processing and americium oxalate precipitation. The processes in this glovebox will remove the remaining plutonium from the feed stock and precipitate americium oxalate from the aqueous solution. The third glovebox will perform waste processing and uses small enough amounts of source material so as not to be of concern. Glovebox 4 houses the oxalate calcination and oxide handling operations. In this box, the oxalate is baked in a calcination furnace for 8 hours, thus converting it to AmO_2 , which is the final product.

Glovebox 1 Model

Detailed models of Glovebox 1 were developed at Los Alamos by A. Crawford [112]. Crawford developed 13 glovebox models each containing different radiation protection measures. As a starting point, the most detailed of these models was taken to represent Glovebox 1. The sides of the glovebox consist of a 0.25-inch lead slab sandwiched between a $3/16^{\text{th}}$ inch slab of 304 stainless steel on the inside and a $1/8^{\text{th}}$ inch slab of 304 stainless steel on the outside. Inside the glovebox is a slab tank that had to be modified to decrease weight so that this 0.25-inch lead slab was replaced with a 0.125-

inch slab of tin. The top and bottom of the box were assumed to be 3/16th inch layers of 304 stainless steel. The inside of the box was layered with 0.09 mil (0.23 cm) of Kynar.²⁰

The viewing windows are made of 0.625-inch leaded glass. For applications involving strong neutron sources, boron-doped glass (borosilicate glass) is preferred over leaded glass due to boron's high neutron-absorption properties; leaded glass is preferred for strong photon sources. Am-241 is a strong photon emitter, and thus leaded glass is preferred. The photon-emission characteristics of the Am-241 source also dictate that leaded gloves be used. For this application 30-mil (0.08 cm) hypalon-lead-neoprene gloves are used. While there is discussion of replacing the lead in these gloves with a composite material, leaded gloves are currently available and in use. In the leaded gloves, two three-section hand-and-arm phantoms were used to determine the extremity dose. Whole body dose was measured by placing 30 cm × 30 cm × 1 cm right perpendicular parallelepiped tally cells at 1 inch and 1 foot from the face of the box. A 3D image of the glovebox described in the model is shown in Figure 19.

²⁰ Kynar, or polyvinylidene fluoride, PVDF, is required in applications where gloveboxes constructed of stainless steel must handle hydrochloric acid (HCl) as the HCl will attack the stainless steel. Kynar is resistant to chloride attack and thus is used to line the glovebox.

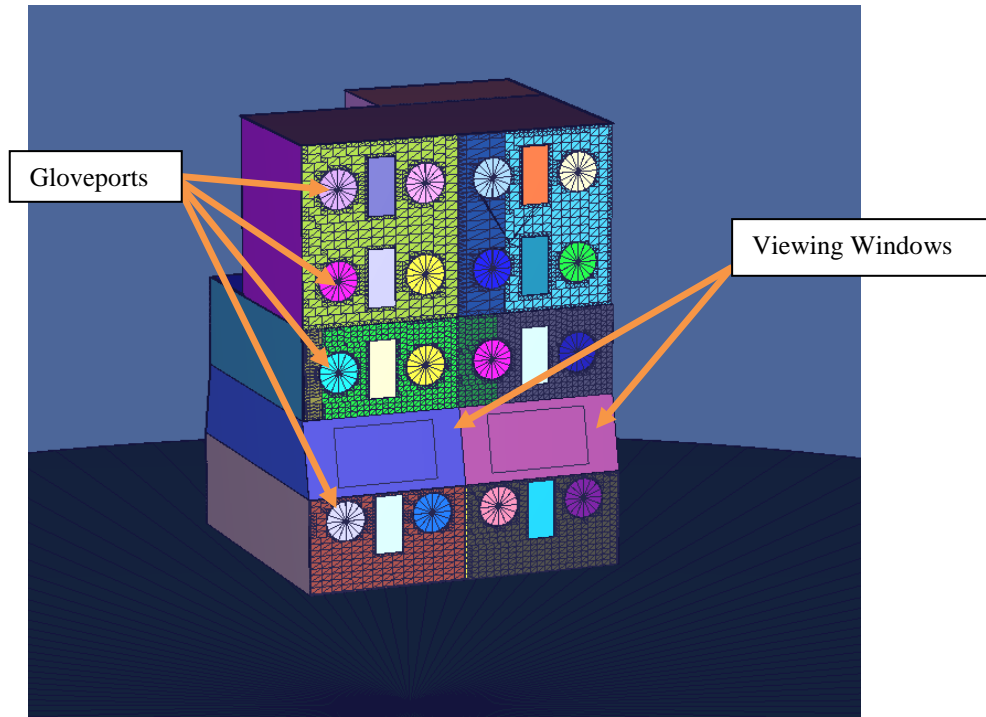

Figure 19. MCNP Visual Editor model of a glovebox used for Am-241 recovery.

The specifications quoted above are presented in Table 18. The source term used in this model was a self-shielded mix of 34-g of americium-241 with 500 g of Pu-239 in hydrochloric acid in an 18.1 L slab tank and an 1.9 L filter boat. Depending on the exposure case, as will be discussed later, the source was either completely in the slab tank, or split between the slab tank and the filter boat. As discussed previously, the slab tank is shielded with 304 stainless steel and an additional 0.125-inch tin shield on the slab tank.

Table 18. Specifications for americium recovery Glovebox 1 modeled in MCNP5 [112].

Glovebox area	Material	Thickness (cm)
Sides		
	Inner Type 304 SS layer	0.47625 cm
	Lead layer	0.635 cm
	Outer Type 304 SS layer	0.3175 cm
Top		
	Type 304 SS Layer	0.47625 cm
Bottom		
	Type 304 SS Layer	0.47625 cm
Inside GB		
	Kynar lining	0.23 cm
Viewing Windows		
	Leaded glass	0.79375 cm
Leaded Gloves		
	Hypalon-Lead-Neoprene	0.08 cm

Glovebox 2 Model

Glovebox 2 [113] , in addition to housing secondary plutonium processing, houses the americium oxalate $(^{241}\text{Am})_2(\text{C}_2\text{O}_4)_3 \cdot 10\text{H}_2\text{O}$ precipitation unit operation. Three-dimensional images of the MCNP model for the glovebox are shown in Figure 20 and Figure 21. Many of the shielding specifications for Glovebox 2 are similar to Glovebox 1 with a few exceptions. The outer surface of the glovebox uses 316 stainless steel as opposed to the 304 stainless found in Glovebox 1. A layer of Kynar was not present in the MCNP model though Glovebox 2 will contain Kynar. For the whole-body calculations, 30-mil gloves were modeled (a conservative assumption) but, for the extremity calculation, credit was taken for the 65-mil gloves that will be present in reality. Glovebox 2 houses a cylindrical tank shielded by a 0.125-inch-thick layer of lead (as opposed to the shielded slab tank in Glovebox 1) that is used for oxalate precipitation

and two extraction chromatography columns used for the secondary plutonium separation. A summary of Glovebox 2 geometric specifications is provided in Table 19.

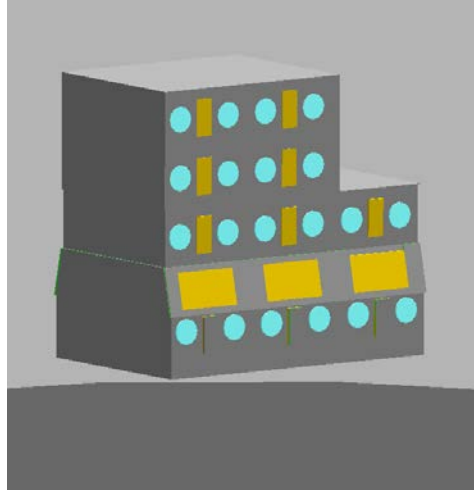

Figure 20. Three-dimensional model of americium recovery Glovebox 2.

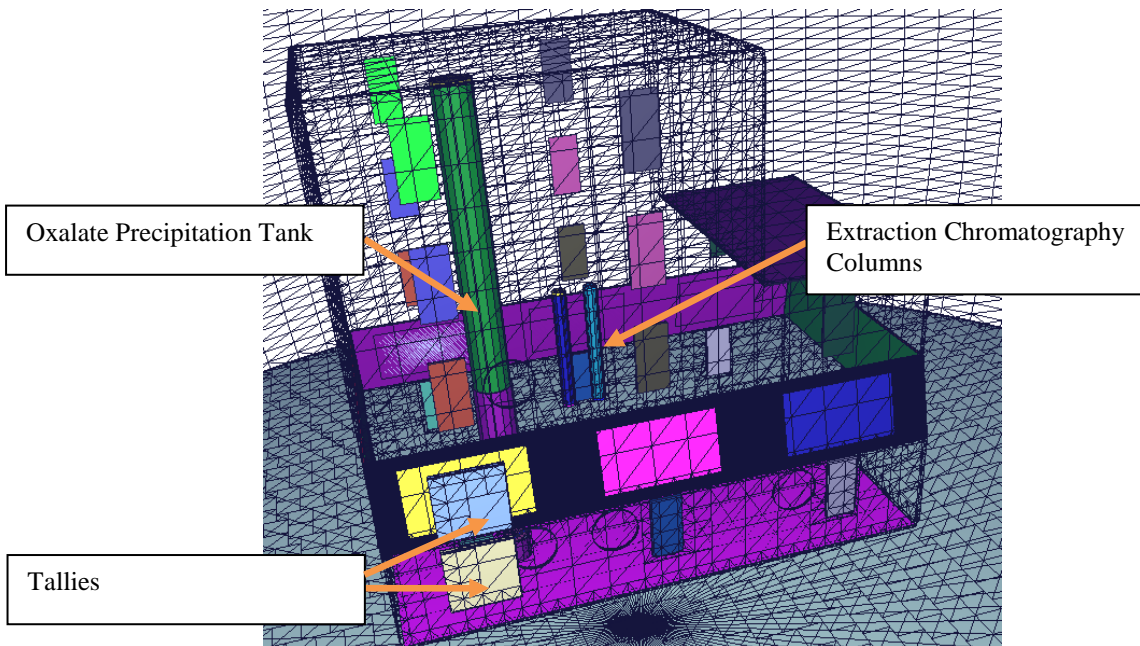

Figure 21. Solid/Wireframe model of Glovebox 2.

Precipitate filtration is performed in a ceramic filter boat. Figure 22 presents a side-by-side comparison of the actual filter boat from Glovebox 2 with its MCNP5 model.

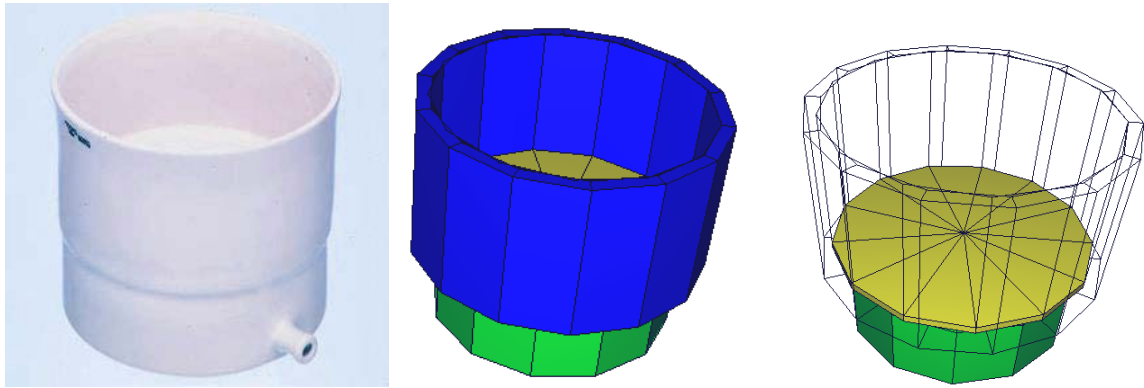

Figure 22. Porcelain filter boat (left), MCNP5 solid model of porcelain filter boat (center), and MCNP solid/wireframe model of porcelain filter boat to illustrate the source location (right).

Table 19. Specifications for americium recovery Glovebox 2 modeled in MCNP5.

Glovebox area	Material	Thickness (cm)
Sides		
	Inner Type 316 SS layer	0.47625 cm
	Lead layer	0.635 cm
	Outer Type 316 SS layer	0.3175 cm
Top		
	Type 316 SS Layer	0.47625 cm
Bottom		
	Type 316 SS Layer	0.47625 cm
Inside GB		
	Kynar lining	None
Viewing Windows		
	Leaded glass	0.79375 cm
Leaded Gloves		
	Hypalon-Lead-Neoprene (whole body/extremity)	0.0762 cm/0.1651 cm
Cylinder Tank Shielding		
	Lead	0.3175 cm

Glovebox 4 Model

Glovebox 4 [114], the calcination glovebox, houses a calcination furnace and a novel piece of equipment – the “pig-that-is-a-jig,” or “pig/jig” for short (formally, the holding jig). The pig/jig is intended to allow workers to twist on the cap for the innermost shipping container (the container making contact with the oxide) without having to hold onto the base (where the dose rates reach around 1 rem/h. A three-dimensional model of the calcination glovebox is shown in Figure 23.

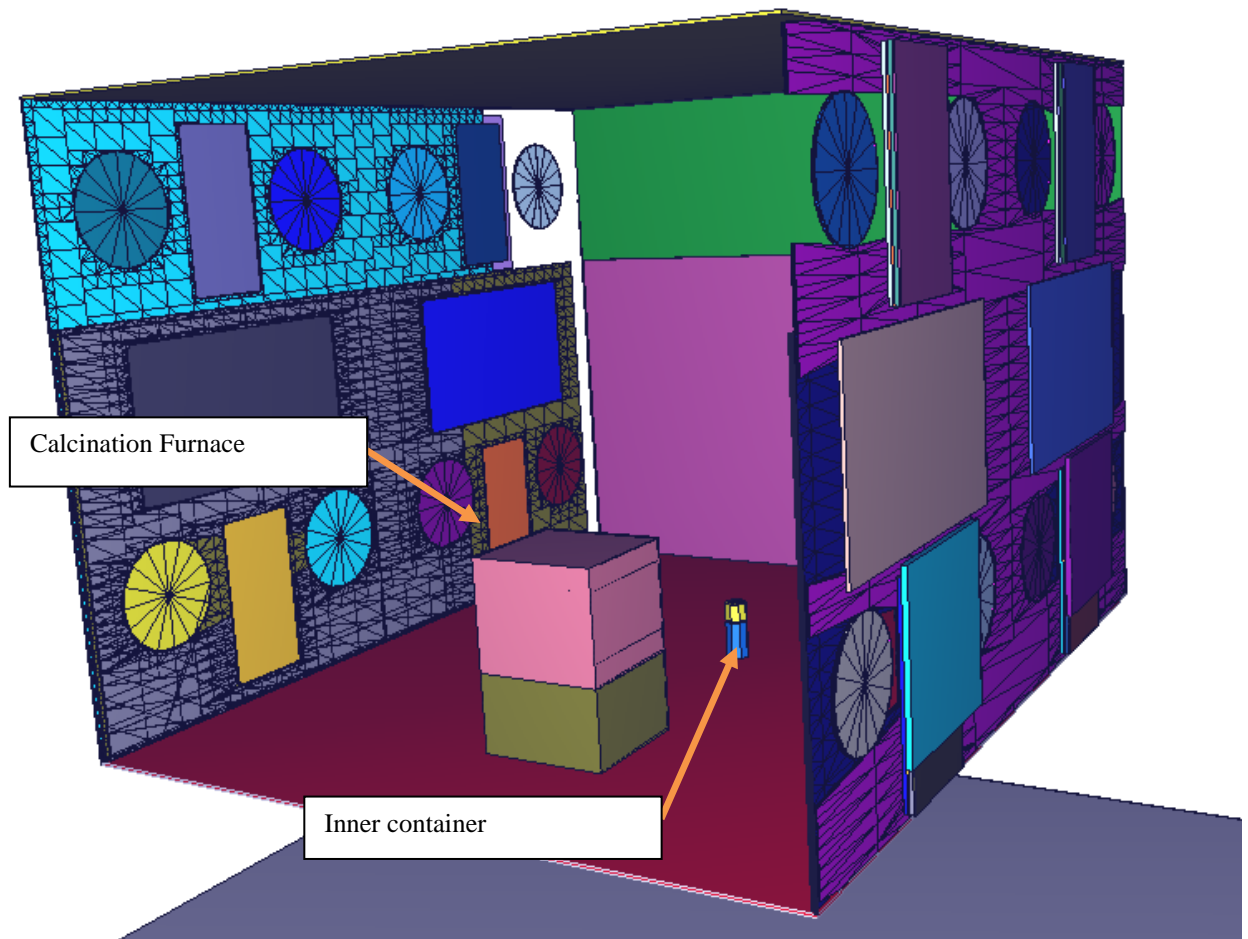

Figure 23. Model image of Glovebox 4 (calcination glovebox). Through the transparent side panel the crucible is visible along with the inner shipping container in the pig/jig.

Glovebox 4 is fabricated entirely out of 316 stainless steel with a wall thickness of 0.476 cm. The glovebox wall includes 0.635 cm lead shield (lead sandwiched between 0.158 cm layers of 316 stainless steel) up to the bend-line above the top of the large viewing windows. Geometric details for the MCNP5 are provided in Table 20. The engineering drawing of the inner container is shown in Figure 24:

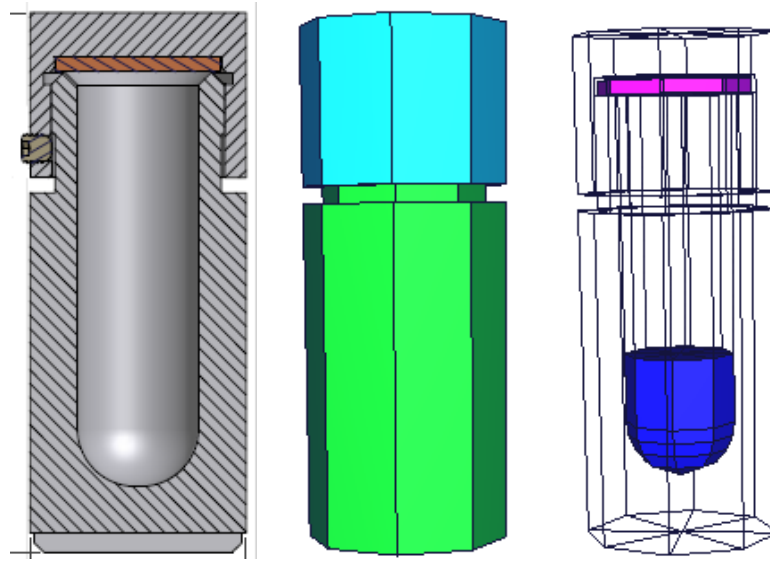

Figure 24. Engineering drawing of innermost shipping container (far left) for americium oxide [115] shown along with its solid (center) and wireframe (far right) MCNP5 models.

An engineering drawing of the pig/jig along with its associated MCNP model is shown in Figure 25.

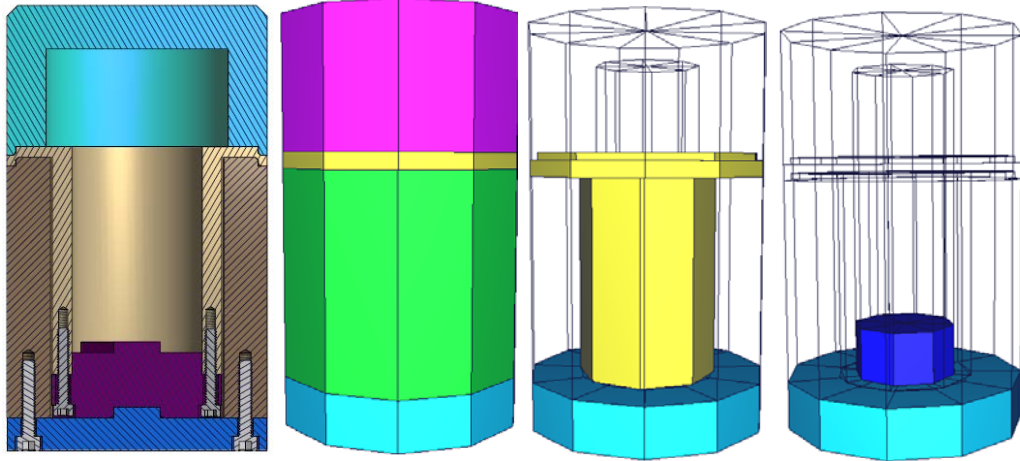

Figure 25. Engineering drawing of the pig/jig (far left) [116] followed by MCNP5 models in various stages of wireframe transparency to show details.

An engineering drawing of the Middle container is shown in Figure 26

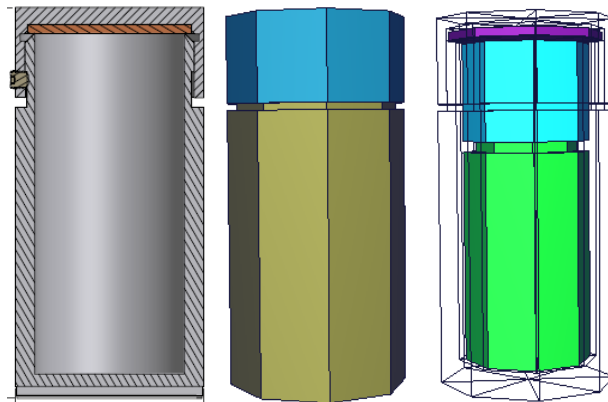

Figure 26. Engineering drawing of middle shipping container (far left) shown along with solid MCNP5 model of middle shipping container (center) and wireframe/solid model of the nested configuration of middle and inner containers (far right). During shipping, the inner container will be nested inside the middle container [117].

Table 20. Specifications for americium recovery Glovebox 4 modeled in MCNP5.

Glovebox area	Material	Thickness (cm)
Shell		
	Inner Type 316 SS layer	0.47625 cm
Shielding		
	Inner Type 316 SS layer	0.3175 cm
	Lead layer	0.158 cm
	Outer Type 316 SS layer	0.3175 cm
Inside GB		
	Kynar lining	None
Viewing Windows		
	Leaded glass	0.79375 cm
Leaded Gloves		
	Hypalon-Lead-Neoprene (whole body/extremity)	0.0762 cm/0.1651 cm
Special Equipment		
	Barnstead Calcination Furnace	N/A
	Holding Jig	

3.3.2 Response Functions

The HP(10,0*) response functions [118], which translate particle fluence to personal dose equivalent, were used because these are the response functions mandated by the Los Alamos National Laboratory radiation protection procedure.

To calculate whole-body dose, cell detectors were placed at 1 inch from the glovebox (and at 1 foot, in the case of Glovebox 1) dictated by the time-motion information using F4 tallies convoluted with the HP(10,0*) [118] response function for ambient dose equivalent at a 10 mm depth in the ICRP slab-geometric phantom. This response function is shown in Figure 27.

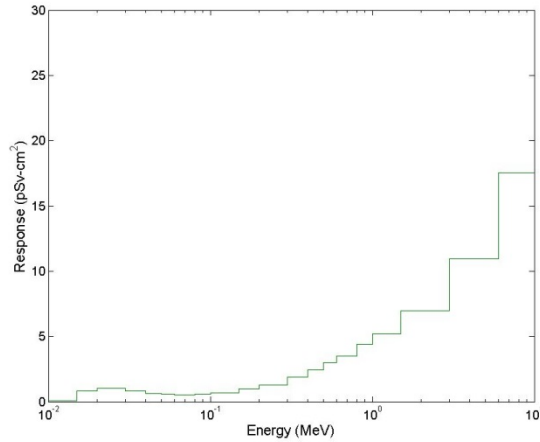

Figure 27. HP(10,0*) personal dose equivalent response function for photons from ICRP 74.

Extremity dose was calculated by averaging over right-circular cylindrical cells at the surface and 10 inches from the source inside the glovebox. F4 cell tallies were used to calculate the flux, which was convoluted with HP(10,0*) response function.

For neutrons, the response function HP(10) was also used. HP(10) are the neutron fluence-to-effective dose-equivalent conversion factors for personal dose equivalent in an ICRP slab. All response functions were taken from ICRP 74. This response function is shown in Figure 28.

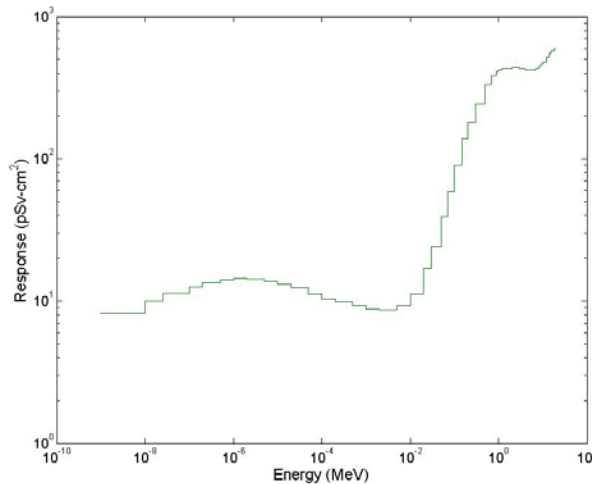

Figure 28. Hp(10) personal dose equivalent response function for neutrons.

While Monte Carlo transport methods are valuable tools for creating detailed exposure models, they are computationally expensive. If an analyst or engineer wishes to model an entire glovebox facility, a tool like MCNP quickly becomes unmanageable. The dose incurred by the worker from their immediate task (called the primary dose) is only a portion of his total dose; other radiation sources in the same room must also be taken into account. [19]²¹ Estimating this secondary dose is typically done by measuring background dose rates in the room.

3.3.3 Time-Motion Study

Motivation for Time-Motion Study

An important piece in the development of an occupational radiological assessment is the development of a time-motion study. Time-motion studies are based on experts' estimations of the amount of time required to perform the unit operations comprising a

²¹ This is called secondary background dose. Primary background dose refers to sources external to the room such as cosmic radiation and radionuclides in building materials.

larger process (henceforth “time data”) as well as the physical location of the operator’s trunk and extremities (“motion data”). These data can be used to estimate production rates or can be combined with dose calculations to estimate the total dose incurred by performing an entire cycle of operations. Time-motion data is also instrumental in initial phases of the analysis as the information provided by the subject matter experts often aids the analyst in the development of exposure cases.

Development of the Time-Motion Study

Time-motion studies came to favor in the first half of the 20th century as a business practice intended to increase worker efficiency [119]. In the context of radiation protection design, the results of a time-motion study are used during the exposure case-development phase of the analysis to determine the exposure geometry that must be modeled.

In many cases, time-motion studies are performed for operations that have been in practice for some time. In a situation such as is found in the development of a new process such as the Americium Recovery Project, the study-development process typically consists of successive interviews and observation sessions with multiple subject matter experts (SMEs) involved with each step of a given process. In these cases, the analyst typically observes the process under consideration, uses a stopwatch to measure time the operator or SME spends at various distances from the source, which are typically measured in a non-radiation environment. This is an iterative process where the analyst and subject matter expert continue to modify the data until a consensus is reached. An

example flow sheet for the development of a typical time-motion study is shown in Figure 29.

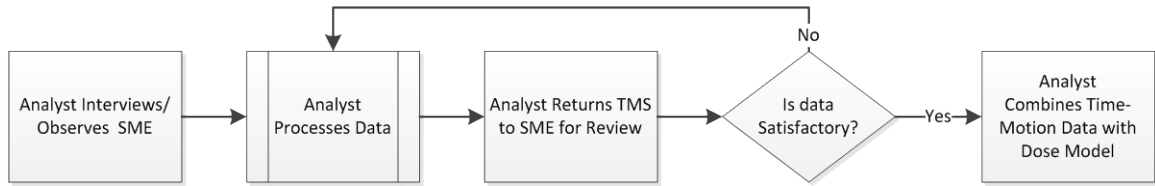

Figure 29. Example flow sheet for the development of a time-motion study for operations currently in practice.

With proposed operations such as those to be performed in the americium recovery operations, typically there are few individuals with the experience to estimate the time and motion data. Because these processes are still at various phases of development, time-motion studies serve an important role in the engineering of the total system. For these cases, it is important that close contact be maintained between the radiological engineers and the SME(s). An example flow sheet for this case is shown in Figure 30.

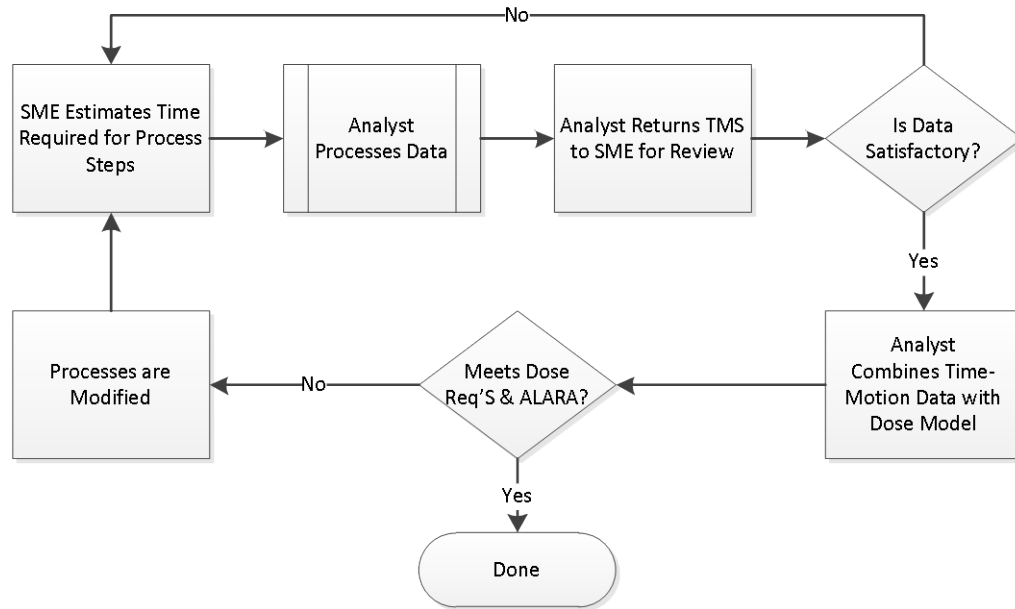

Figure 30. Example flow sheet for the development of a time-motion study for proposed operations.

In the current project, several unit operations intended for the americium recovery operations are currently operational, though in other contexts. Thus, estimates of time and motion data for these processes are subject to less uncertainty in estimation than if these operations were purely notional.

Inputs for Time-Motion Study

The time and motion data describe time spent at various distances from either the source (for extremity dose) or the glovebox face (for whole-body exposure). The extremity data present times spent at two and ten inches from the source performing different manual tasks. Two inches from the source is taken to be the surface of any applicable container. In the case of Glovebox 1, when the source was split between the slab tank and the filter boat, the distances were taken as 2 and 10 inches from the slab-tank face at the height of the glove ports. The whole-body data present times spent at one and two feet from the

glovebox face. Times estimated at one inch from the glovebox face represent the time the worker spends with hands in the glovebox while times estimated at two feet from the glovebox typically represent times spent observing the glovebox with hands out of gloves. For some unit operations, a large majority of the operator's time is spent away from the glovebox. These times are also estimated as part of the time-motion study and the dose rates during these times (both whole body and extremity) are estimated using the typical background dose rate in the room. The conservative assumption was made that dose rates at two feet from the glovebox face were the same as those at the surface. For Glovebox 1, in the case where the source was split between the tank and the filter boat, the one-inch dose rate was taken as the dose rate at the glove port nearest to the filter boat and the two feet dose rate was taken as the dose rate between the glove ports.

Results of Time-Motion Study

Introduction and Dissolution

The first activity performed is the transfer of the feed material from the PF-4 vault to the area where the processes will occur. The material is removed from the vault by cart, and is moved to the room. The material is then placed on the trolley by way of the introduction hood. The material is transferred from the intro hood to the work environment using the trolley system. Because these processes are currently in practice and are beyond the scope of the americium-recovery operations, they are not analyzed from a time-motion perspective. With the exception of the analysis of Glovebox 1, the conservative assumption is made that, in calculating whole-body dose, all time is spent at

the closest distance defined in the time-motion study. The various distances are, however, used for the extremity calculations for all gloveboxes.

Primary Plutonium Separation

Primary plutonium separation takes place in Glovebox 1 and consists of feed treatment to put the plutonium into the +4 valence state followed by two anion exchange processes to remove plutonium from the solution and purify the americium. The time and motion data for primary plutonium processing is shown in Table 21.

Table 21. Time and motion data for primary plutonium processing. Times listed are in hours.

Unit Operation	Extremity			Whole Body		
	2 inch	10 inches	Out of gloves	1 inch	1 foot	Room background
Filtration	0.05	0.5	2	0.55	0.5	2.55
Column Prep	0.05	0.5	2	0.55	0.5	2.55
Column Load	0.1	1	6	1.1	1	7.1
Column Wash	0.05	0.5	4	0.55	0.5	4.55
Column Elution	0.05	0.5	4	0.55	0.5	4.55
Pu Soln. Transfer	0.05	0.1	2	0.15	0.1	2.15
Am Soln. Transfer	0.05	0.1	2	0.15	0.1	2.15

Secondary Plutonium Separation and Americium Extraction Chromatography

Further purification of actinides from the process effluent solution is performed in Glovebox 2 by plutonium anion exchange followed by extraction chromatography that removes and purifies the vast majority of americium (>99%). The time and motion data for these processes are shown in Table 22.

Table 22. Time and motion data for secondary plutonium processing and americium extraction chromatography.

Unit Operation	Extremity			Whole Body		
	2 inch	10 inches	Out of gloves	1 inch	1 foot	Room background
Column Prep	0.1	0.1	2	0.2	0.1	2.2
Column Load	0.2	0.4	6	0.6	0.4	6.6
Column Wash	0.1	0.1	4	0.2	0.1	4.2
Pu Column Elution	0.1	0.1	4	0.2	0.1	4.2
Am Column Elution	included with above operation					
Pu Soln. Transfer	0.1	0.1	2	0.2	0.1	2.2

Americium Oxalate Precipitation

After extraction chromatography, the purified americium eluate solution is combined with oxalic acid dihydrate. This precipitates the americium from the eluate as americium oxalate. This process takes place in the same glovebox as secondary anion exchange and extraction chromatography (Glovebox 2). The time and motion data for the americium oxalate precipitation unit operation is shown in Table 23.

Table 23. Time and motion data for americium oxalate precipitation. Times shown are in hours.

Unit Operation	Extremity			Whole Body		
	2 inch	10 inches	Out of gloves	1 inch	1 foot	Room background
Chemistry Adjust	0.05	0.1	2	0.15	0.1	2.15
Filter Boat Prep	included with above operation					
Reagent Addition	0.05	0.1	1	0.15	0.1	1.15
Digestion	0.05	0.1	1	0.15	0.1	1.15
Filtration	0.05	0.1	1	0.15	0.1	1.15
Washing	included with above operation					
Air Dry	0.01	0.1	3	0.11	0.1	3.11
Am oxalate handling	0.01	0.1	0	0.11	0.1	0.11
Am oxalate transfer	0.1	1	2	1.1	1	3.1

Americium Calcination and Oxide Handling

The americium oxalate cake precipitated from the precipitation unit operation is transferred to a separate glovebox containing a calcination furnace where it is converted to americium oxide. After calcination, the oxide is weighed, blended, and sampled. The time and motion data for calcination and oxide handling is shown in Table 24.

Table 24. Time and motion data for calcination and oxide handling processes. Times shown are in hours.

Unit Operation	Extremity			Whole Body		Room background
	2 inch	10 inches	Out of gloves	1 inch	1 foot	
Oxalate Calcination						
Loading Furnace	0.01	0.1	0	0.11	0.1	0.11
Furnace Cycle	0	0.05	2	0.05	0.05	2.05
Unloading Furnace	0.05	0.1	1	0.15	0.1	1.15
Am ₂ O ₃ handling						
Weighing in crucible	0.01	0.1	1	0.11	0.1	1.11
Weighing in innermost C.	0.05	0.1	1	0.15	0.1	1.15
Blending	0.01	0.1	2	0.11	0.1	2.11
Combine/Split	0.05	0.2	2	0.25	0.2	2.25
Sampling	0.01	0.1	1	0.11	0.1	1.11

The final steps that were considered are the bagging of the batch (removal from the glovebox) and the carting of it back to the vault. The time and motion data for these steps is shown in Table 25. The whole-body dose for the case when the source is outside of the glovebox was taken as the personal dose equivalent at 13.5" from the inner-container surface.

Table 25. Time and motion data for removing the batch from the glovebox line. Times shown are in hours.

Unit Operation	Extremity			Whole Body		Room background
	2 inch	10 inches	Out of gloves	1 inch	1 foot	
Trolley	0.1	0.2	2	0.3	1	3
Bagout	0.05	0.1	1	0.3	-	3
Cart	-	-	0.5	-	-	1
Vault	-	-	1	-	-	1

The planning basis for the ARP suggests that 25 batches will be produced per year. This would multiply these time values by a factor of 25. The times for a single operation are compared to those for 25 operations in Table 26.

Table 26. Total times for 1 and 25 complete americium operations. Background is the times spent with hands not in gloves. Background includes time spent in glovebox 3 the processes in which were not modeled.

	Extremity		Whole Body		
	In Gloves	Out of gloves	Distance 1	Distance 2	Background
Total time (hrs) (1 operation)	9.42	67.5	9.27	14.65	93.82
Total time (hrs) (25 operations)	235.5	1678.5	231.75	366.25	2,346

3.3.4 Marginal Risk-Benefit Analysis

Based on the results of the time-motion study and assuming a 2,000-h work year (40 h/wk and 50 wk/year), one person cannot complete the 25 yearly operations mandated by the planning basis for the ARP. Further, a study of workplace efficiency at TA-55 has demonstrated that employees are only engaged in productive work 42% of their time [110]. Additionally, the secondary background in the room where the ARP activities will take place maintains an average background of 1 mrem/hour (with locally higher areas) which is twice the 0.5 mrem/year design goal. Thus, multiple operators

must be employed to satisfy the production requirements, both from a time and radiological perspective.

To estimate an optimal number of workers, this work develops a framework for applying marginal risk-benefit analysis to a hazardous-environment staffing problem. Typically, discussions of risk-benefit analysis center on a “willingness to pay,” which describes an individual’s desire to trade some amount of risk to derive some benefit [12]. A common example is automobile driving; drivers accept the risks inherent with automobile operation in exchange for increased mobility. Workers in hazardous industrial environments also implicitly set a value for their willingness to accept risk by accepting a job offer at a given rate of compensation. Compensation *does not* refer to the worker’s take-home pay; it refers to the amount the organization pays to hire them. This amount is referred to as the burdened cost of an employee and includes among other things facilities (including safety and security infrastructure), and administration. By accepting an offer of employment, the worker is agreeing that the amount the organization pays to keep them employed is commensurate with their level of risk.

Thus, to determine the optimal number of workers for the ARP, the change in risk (marginal risk) per individual will be compared with the change in compensation (marginal benefit) per individual as the americium-production work is spread among a growing number of employees. In both cases, these are negative as the risk and the compensation are decreasing.

An additional consideration is that the Department of Energy mandates that exposures to radiation be kept ALARA. Thus, the change in compensation, as well as the

change in risk will be compared with the Los Alamos definition of an ALARA-reasonable expenditure. Los Alamos has defined reasonable ALARA expenditures as \$2,000 per person/rem avoided and \$10,000 per person rem avoided for people approaching their 2-rem limit [19]. From the perspective of the Los Alamos Radiation protection policy, “approaching their two-rem limit” will imply that the employee has exceeded the Laboratory’s action level²² for whole body radiation of 1 rem in a year whole body. There is, however, a tendency to reduce this action level locally (at the group and division level) [120]. Thus, analysis will be performed for the action levels of 500 mrem, 800 mrem, and 1 rem, all of which either have been or are currently implemented as proposed dose limits or action levels.

Monetization of Risk and Calculation of Monetary “Risk Value”

Value of Statistical Life

To estimate the number of operators required to reduce the individual doses below acceptable levels, defined as the Laboratory’s ALARA-reasonable expenditures, monetary estimates of the risk incurred by the employees can be used. There are several ways this can be done: by assuming that individuals are similar to a type of capital equipment whose potential output is lost on its premature demise, by recent damages awarded by courts to the surviving family members of a person killed in an industrial accident, or by assessing the probability of death from engaging in a certain activity and estimating the insurance premium used to cover the risk [21]. An additional approach that has been applied is to determine an estimated value of the cost per unit dose, using methods of estimating the value of statistical life [121]. This research will use a similar

²² Action levels are dose thresholds that require notifying the worker, the responsible line manager (RLM), and radiation protection management. Radiation protection personnel issue these notifications electronically after dosimetry data become available. After making appropriate modifications to the activities and/or work area, the RLM must track additional dose against applicable limits [19].

method by monetizing the relative risks developed in this work using the EPA's estimated value of statistical life: \$8.6 million (in 2014 dollars) [122], [123]. The EPA's value of statistical life is based on estimates of how much individuals are willing to pay for small reductions in their risks of dying from adverse health conditions that may be caused by environmental pollution; in the present case, this is taken to be occupational exposure to ionizing radiation.

The conceptual derivation of the value of statistical life is described by the National Center for Environmental Economics as [122]:

In the scientific literature, these estimates of willingness to pay for small reductions in mortality risks are often referred to as the "value of a statistical life." This is because these values are typically reported in units that match the aggregate dollar amount that a large group of people would be willing to pay for a reduction in their individual risks of dying in a year, such that we would expect one fewer death among the group during that year on average. This is best explained by way of an example. Suppose each person in a sample of 100,000 people were asked how much he or she would be willing to pay for a reduction in their individual risk of dying of 1 in 100,000, or 0.001%, over the next year. Since this reduction in risk would mean that we would expect one fewer death among the sample of 100,000 people over the next year on average, this is sometimes described as "one statistical life saved." Now suppose that the average response to this hypothetical question was \$100. Then the total dollar amount that the group would be willing to pay to save one statistical life in a year would be \$100 per person \times 100,000 people, or \$10 million. This is what is meant by the "value of a statistical life." Importantly, this is not an estimate of how much money any single individual or group would be willing to pay to prevent the certain death of any particular person.

The term "value of statistical life" is slowly being replaced with "value of mortality risk reduction" [124].

Dose spreading

As the number of workers employed by the ARP increases, the dose can be assumed to decrease by a factor of $1/n$, where n is the number of workers. Thus, with the LNT assumption, the risk to each individual is calculated as:

$$Risk = \beta \frac{D}{n} \quad (2.3)$$

where β is the excess relative risk per unit dose for all deaths, D is the total dose per year for 1 person performing 25 americium operations, and n is the number of workers incurring dose. The monetary value of this risk, called the “risk value,” is found by multiplying the risk by the EPA’s estimated statistical value of life (denoted as σ):

$$\text{Risk Value}_{LNT} = \sigma \beta \frac{D}{n} \quad (2.4)$$

Taking the first derivative of equation (2.4) with respect to the number of employees yields the change in risk value that occurs when the workforce size changes by one operator, referred to as the “marginal risk value.” This quantity is given by

$$\text{Marginal Risk Value}_{LNT} = \sigma \beta D \frac{\partial}{\partial n} \left(\frac{1}{n} \right) = \sigma \beta D \left(-\frac{1}{n^2} \right) . \quad (2.5)$$

To find the minimum number of employees required to maintain individual doses (and hence risks) ALARA, the marginal risk value will be compared with the marginal ALARA expenditures. The marginal ALARA value represents the change in ALARA-reasonable expenditures affected by changes in the number of employees.

For individual doses above the m-rem (say $m = 1$ rem for concreteness) watch level, the ALARA values are determined as follows. First, the dose above one rem to each employee (found by subtracting 1 rem from the dose to each employee) is multiplied by the number of exposed employees and by \$10,000, which is the amount deemed reasonable to spend to reduce each individual’s dose to 1 rem. This value is summed with the \$2,000 per person-rem avoided figure. This is also multiplied by the number of exposed employees. For individual doses less than 1 rem, the ALARA value is simply the

product of the number of employees, the dose to each employee, and the \$2,000

ALARA-reasonable value. This is shown as a piecewise function in Equation (2.6).

$$ALARA\ Value = \begin{cases} \left(\$10000 \left(\frac{D}{n} - m \right) + \$2000 \cdot m \right) n & \frac{D}{n} > m \\ \$2000 n \frac{D}{n} & \frac{D}{n} < m \end{cases} \quad (2.6)$$

In Equation (2.6), m represents the action-level dose (measured in rem) beyond which the “reasonable” expenditure value increases to the higher level. D represents the total dose one employee would incur if he performed all 25 operations. The dose D is divided by n , the number of employees, to give the dose to each individual employee. The first derivative of Equation (2.6) is the marginal ALARA value. The recommended minimum number of employees is then determined by finding the value of n that causes the marginal risk value to intersect with the marginal ALARA value.

Along with the marginal risk values and the marginal ALARA values, the marginal benefit (the change in burdened cost per employee as the staffing level is increased) per worker is calculated and presented. This is done under the assumption that the burdened (programmatic) cost of each worker is \$132 per hour [125]. Thus, the total staffing cost of completing 25 batches of americium per year will be $132\ dollars / hr \cdot 2346\ hr = \$309,762$ per year. This will be spread across the n workers employed and the rate of change as workers are added will be compared with the change in risk and the change in ALARA value.

3.4 Results

This analysis finds that appropriate radiation protection measures are in place to maintain occupational doses to workers in the americium recovery operations below current design goals. This analysis is considered to be conservative, so fluctuations in yearly production are unlikely to be of concern from a radiological perspective.

Several assumptions were made when calculating the doses and comparing them to the time-motion data. For the Glovebox 2 and Glovebox 4 operations, the whole-body doses at both distances from the glove ports were taken to be the dose at one inch from the viewport between the glove ports with the cover off. For Glovebox 1, the dose rates were calculated at one inch and two feet from the maximally affected port. For Glovebox 2, dose rates were calculated the viewport between the glove ports with the viewport cover off. For Glovebox 4, doses were taken at one inch from the leaded view port in front of the source. Secondary background dose was assumed to be equal to 1 mrem/h based on measurements taken by the radiation protection organization at Los Alamos. The time-motion study indicates that 81.8 hours will be spent per operation in the room with the americium process. If 25 batches are to be processed, it will require 2,346 hours per year and incur a background dose of 1,023 mrem/year whole body. For secondary background dose to the extremities, the time out of gloves was taken as the exposure time. Glovebox 3, while being of negligible radiological concern from a process standpoint, is located in an area with locally higher secondary background radiation²³. Thus, the secondary background dose to the whole-body is the highest radiological concern.

3.4.1 Whole-body Results

Table 27 shows the contact times and calculated whole-body doses for each process in the americium recovery operations.

Table 27. Total times and whole-body doses for americium operations segregated by glovebox. "Yearly" values assume 25 operations per year. Time includes all time spent in the room including contact time.

Glovebox	Operation	Time per batch (h)	Yearly time (h)	Dose per batch (mrem)	Yearly dose (mrem)
Glovebox 1	Primary Pu Processing	27.15	678.75	17.632	440.8
	Glovebox 1 Total	27.15	678.75	17.632	440.8
Glovebox 2	Secondary Pu Processing	20.60	515.00	1.935	48.38
	Am Oxalate Precipitation	11.92	298.00	9.764	244.09
	Glovebox 2 Total	32.52	813	11.699	292.47
Glovebox 4	Am Oxalate Calcination	3.42	85.50	1.575	39.38
	Am Oxide Handling	7.73	193.25	3.484	87.104
	Material Out	11.00	275.00	4.788	119.7
	Glovebox 4 Total	22.15	553.75	9.847	246.184
Sum of all Gloveboxes		81.82	2045.5	39.18	979.5
Glovebox 3	Secondary Background	12 ²³	300	26.8	670
Total Secondary Background		93.82	2,346	93.82	2,346
Sum with background		-	-	133.0	3,325.5

The photon and neutron contributions to whole body dose are shown in Table 28.

Table 28. Photon and Neutron contribution to whole-body dose from each unit operation in the americium recovery project.

²³ 4 hours is spent in a 4.7 mrem/h dose field (3.5 gamma, 1.2 neutron), and 8 hours is spent in a 1 mrem/h dose field (0.5 mrem/h gamma and 0.5 mrem/h neutron)

Glovebox	Operation	Photon Contribution		Neutron Contribution	
		Dose per batch (mrem)	Yearly dose (mrem)	Dose per batch (mrem)	Yearly dose (mrem)
Glovebox 1	Primary Pu Processing	15.1	376.6	2.6	64.2
	Glovebox 1 Total	15.1	376.6	2.6	64.2
Glovebox 2	Secondary Pu Processing	0.9	21.8	1.1	26.6
	Am Oxalate Precipitation	7.0	174.2	2.8	69.9
	Glovebox 2 Total	7.8	196	3.86	96.4
Glovebox 4	Am Oxalate Calcination	0.3	7.7	1.3	31.7
	Am Oxide Handling	0.6	15.3	2.9	71.8
	Material Out	3.7	91.6	1.1	28.1
	Glovebox 4 Total	4.6	115	5.26	132
Sum of all Gloveboxes		27.49	687.19	11.69	292.26

It is clear that the background dose is the largest concern with respect to whole body. The glovebox doses represent the conservative case of doses at the central viewport without a viewport cover. This assumption is conservative because, during normal operations, the viewport will have a cover installed. Time and dose per operation in the table refer to the time spent and the dose incurred in processing one batch. The “yearly” values are the times and doses under the assumption of 25 batches per year.

To illustrate the relative demand of each operation in terms of contact time and dose, Figure 31 shows pie charts of the worker time per operation and whole-body dose per operation respectively. Note that though americium oxalate calcination and americium oxide handling are relatively short operations from a contact-time perspective, they are two of the highest-dose operations and demand the most attention from

radiological engineering. Conversely, the “material out” operation is relatively lengthy but results in one of the lowest doses.

A potential area for further study is the blending operation. Before the radiological protection organization can adequately analyze blending operations, the operation will require further specification. Blending is likely to be of significant radiological concern because it will require significant time with hands near the source material and therefore it warrants further study.

Figure 31. Whole Body Dose per operation for a single batch (left) Worker Time (in hours) per operation for a single batch (right).

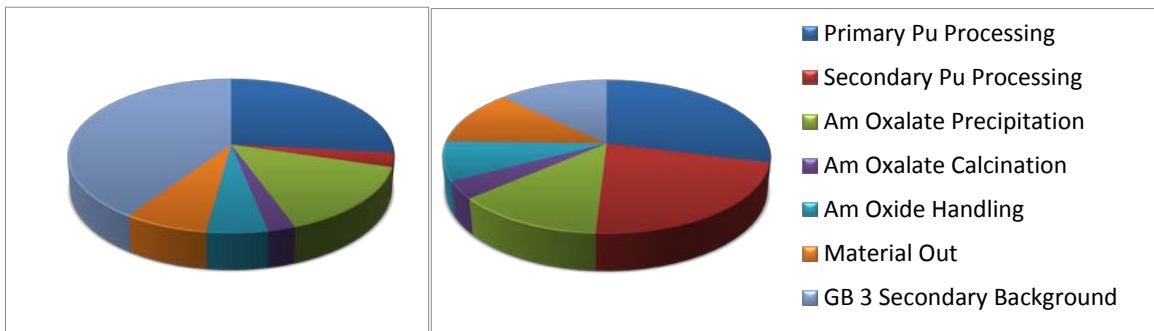

3.4.2 Extremity Dose

Extremity dose is of most concern in these operations. For the “material out” operation, MCNP calculations were performed at the surface of and six inches from the inner container. The other cases were assumed to have dose rates equal to those associated with the filter boat shielded by 0.125 inches of lead and 30-mil leaded gloves. Dose rates were calculated at the surface of the filter boat and at a distance of 10 cm at a height equal to the center of the source inside the boat.

Table 29 presents the extremity doses per batch and per year (assuming 25 batches per year) for each set of operations in the americium recovery operations. Under the current assumptions, it is estimated that the total extremity dose associated with one batch would be 558.1 person-mrem leading to a yearly dose of 13,952.5 person-mrem under the assumption of 25 batches per year. As discussed before, the 30-mil thick leaded gloves were assumed for operations Gloveboxes 1 and 4. Operations in Glovebox 2 were modeled using 65-mil gloves. The use of 65-mil gloves is being discussed in the other gloveboxes. However, more detailed information is required to assess whether or not the use of 65-mil gloves will significantly affect process times; the dexterity of the operators will be compromised by the use of lead-lined gloves that are over twice as thick. Longer process times and decreased dexterity will increase exposure time and thus dose. Whether or not this increase in exposure time will lead to doses comparable with 30-mil gloves remains to be seen. A follow-on activity would be to work with the SMEs to estimate process time changes with the thicker gloves and perform a new dose analysis with the new time-motion data to support comparative analysis.

Table 29. Doses to the extremities per batch and per year for each operation broken down by glovebox. Yearly values assume 25 batches per year. Times presented in “Sum with Background” row represent the time spent out of gloves.

Glovebox	Operation	Time per batch (h)	Yearly time (h)	Dose per batch (mrem)	Yearly dose (mrem)
Glovebox 1	Primary Pu Processing	4.15	103	101.5	2536
	Glovebox 1 Total	4.15	103	101.5	2536
Glovebox 2	Secondary Pu Processing	1.6	40	8.10	203
	Am Oxalate Precipitation	1.92	48	158.99	3974
	Glovebox 2 Total	3.52	88	167.09	4177
Glovebox 4	Am Oxalate Calcination	0.42	10.5	25.67	641
	Am Oxide Handling	0.73	18.25	94.52	2363
	Material Out	0.6	15	94.13	2353
	Glovebox 4 Total	1.75	43.75	214.3	5358
Sum of all Gloveboxes		9.42	234.75	482.8	12,070
Glovebox 3	Secondary Background	8	200	8	200
All Processes	Total Secondary Background	75.5 ^{24,25}	1888	75.5	1888
	Sum with background	92.9	2,323	558.1	13,958

The photon and neutron contributions to extremity dose from these operations are shown in Table 30.

²⁴ This is derived from 67.5 hours out of gloves (from the time motion study) for gloveboxes 1, 2 and 4 added to 8 hours out of gloves for glovebox 3.

²⁵ System Functions and Requirements Analysis for Am-241 Recovery Operations, Los Alamos National Laboratory (2010) LA-CP-10-1109

Table 30. Photon and neutron contributions from each unit operation modeled in the americium recovery project. Omits secondary background

Glovebox	Operation	Photon Contribution		Neutron Contribution	
		Dose per batch (mrem)	Yearly dose (mrem)	Dose per batch (mrem)	Yearly dose (mrem)
Glovebox 1	Primary Pu Processing	95.82	2,396	5.64	141
	Glovebox 1 Total	95.82	2,396	5.64	141
Glovebox 2	Secondary Pu Processing	6.21	155.3	1.89	47.34
	Am Oxalate Precipitation	153.1	3,827	5.89	147.2
	Glovebox 2 Total	159.3	3,982	7.8	195
Glovebox 4	Am Oxalate Calcination	23.87	596.7	1.80	45.01
	Am Oxide Handling	69.61	1740	24.91	622.87
	Material Out	65.09	1627	29.04	725.91
	Glovebox 4 Total	158.6	3,963	55.75	1,394
Sum of all Gloveboxes		413.67	10,340	69.2	1,730

Dose from Transport of Samples to Analytical Chemistry

Samples (~35 mg of AmO₂) will be taken from each batch and transported to the Los Alamos analytical chemistry group for characterization. This operation is not included in the dose analysis because the dose rate at 30 cm from the source with no shielding is found to be 72.5 mrem/h, which is below the 100 mrem/h at 1 foot (30.48 cm) threshold above which a radiation work plan is necessary per the Los Alamos National Laboratory safety-basis organization.

3.4.3 Estimating the Minimum Number of Workers to Maintain Risks at Acceptable Levels

As discussed above, the 25 operations per year cannot be performed by a single individual based on both dose and time constraints; a single worker would require over

84 weeks to complete 25 operations based on a 40-hour work week and would exceed their federal limit for both whole body and extremity dose.

The ratio of extremity dose to whole body dose is roughly 5:1. The administrative control level for extremity dose at Los Alamos is 20 rem per year; thus, the ratio of the whole-body dose limit to the extremity dose limit is 10:1 which is sufficiently large to allow a broad range of work. Table 31 compares the dose incurred by each employee under the assumption that with each additional employee the work (and dose) is spread evenly among them.

Table 31. Dose incurred by employees with varying workforce sizes.

# employees	Yearly Hours Worked	Whole Body (rem/year)	Extremity (rem/year)
1	2,346	3.325	13.958
2	1,173.5	1.663	6.979
3	782	1.108	4.653
4	586.5	0.831	3.490
5	469.2	0.665	2.792
6	391	0.554	2.326
7	335	0.475	1.994

By the federal mandate of ALARA [111], the dose-response model required when designing or optimizing radiation protection schemes is the linear, no-threshold model. Thus, the LNT model calculated in the previous chapter for all-cancer risks will form the foundation of this study. However, it is interesting to examine the use of non-linear dose-response data. Thus for comparison, risk values calculated based on the binned results are also considered.

Comparing Programmatic Cost and Benefit

This section will compare the ALARA reasonable expenditures with the marginal cost per employee. The ALARA-reasonable expenditure is defined as the difference in the amount of programmatic dollars that is “reasonable” to spend to further divide the dose by additional workers. Because lower doses per individual result in lower ALARA-reasonable expenditures, the amount saved (defined to be a negative change) increases in magnitude. Thus, the benefit is considered to be the difference between the ALARA-reasonable amount for n employees and the ALARA-reasonable amount for 1 employee. This analysis is performed for watch levels of 1 rem, 800 mrem and 500 mrem.

Cost Benefit at a 1-rem Watch Level.

When comparing the programmatic benefit (the reduction in ALARA-reasonable cost for n employees when compared with 1 employee), at a watch level of 1 rem, Figure 32 demonstrates that approximately 3.3 employees are required to make the change in cost equal to the benefit. The discontinuity seen in the ALARA-savings line represents the point at which the dose to each individual worker decreases below the watch level, and thus the ALARA-reasonable value decreases to the lower level.

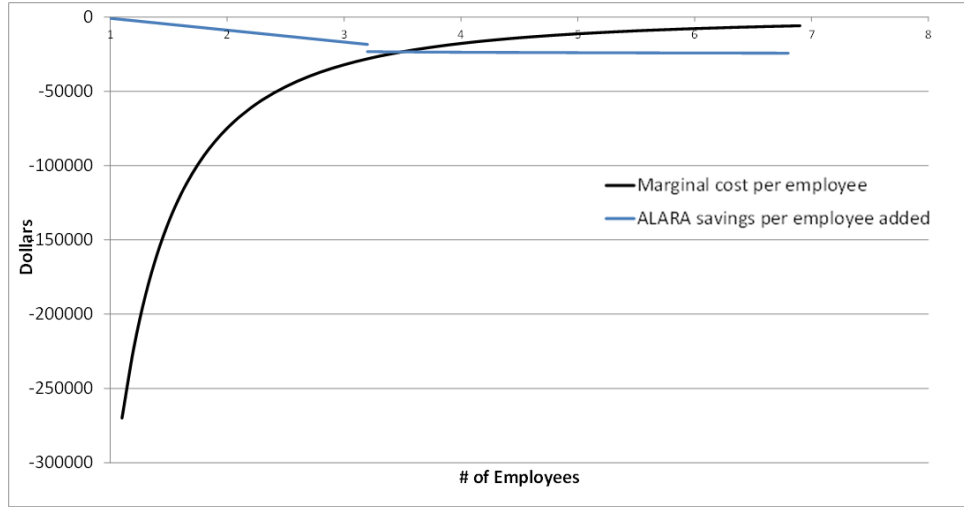

Figure 32. Marginal cost and benefit curves for 1-rem watch level. The benefit is defined as the difference in the ALARA-reasonable expenditure between 1 and n employees. The marginal cost is the change in the amount spent to compensate each employee.

Cost Benefit at an 800-mrem watch level.

At a dose-watch level of 800 mrem, the ALARA-reasonable expenditures increase, and close to 4.15 workers are justified. This is shown in Figure 33.

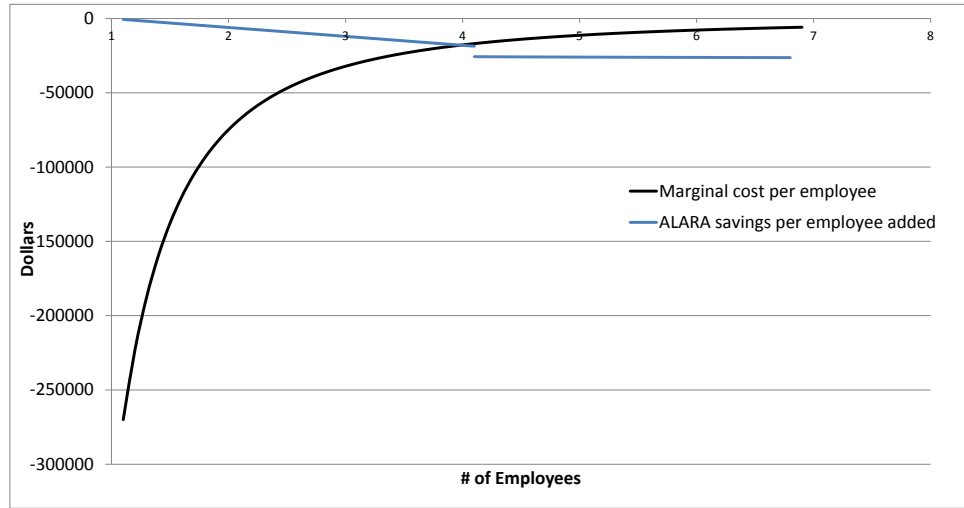

Figure 33. Marginal cost and benefit curves for 800-mrem watch level. The benefit is defined as the difference in the ALARA-reasonable expenditure between 1 and n employees. The marginal cost is the change in the amount spent to compensate each employee.

Cost Benefit at a 500-mrem watch level.

At a dose-watch level of 500 mrem, the ALARA-reasonable expenditures increase more dramatically, and approximately to 4.9 workers are justified as shown in Figure 36.

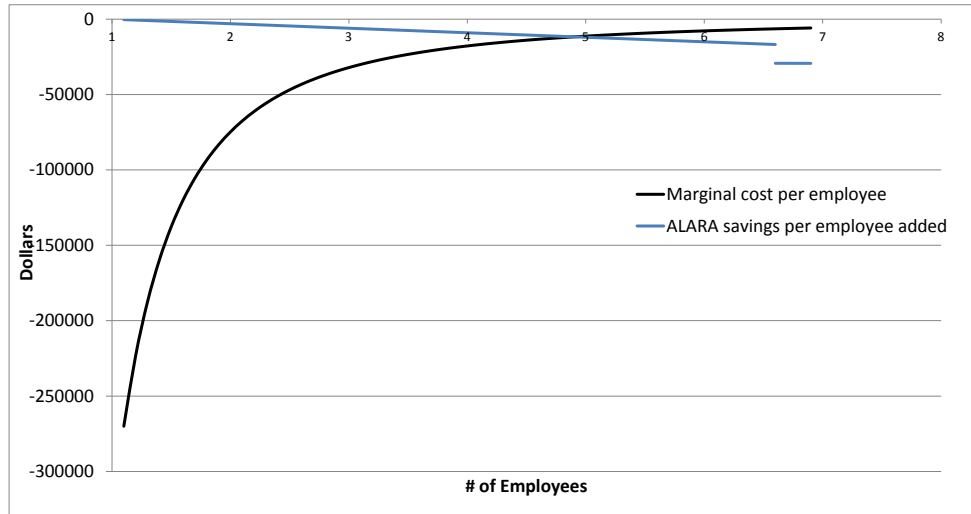

Figure 34. Marginal cost and benefit curves for 500-mrem watch level. The benefit is defined as the difference in the ALARA-reasonable expenditure between 1 and n .

This method of estimating the number of employees is possibly the least controversial because it does not depend on an estimate for the value of statistical life and thus avoids the question of whether employees are being appropriately compensated for the risk they incur. However, setting a value for ALARA-reasonable is difficult, as discussed in Chapter 1, and monetary estimates of risk will necessarily come into play in their derivations.

Marginal Risk-Benefit Analysis Considering LNT and Bin-averaged Estimates of Risk

Figure 35 compares the marginal risks for each dose-response model (linear and bin-averaged) with the marginal benefit to each worker of adding additional employees.

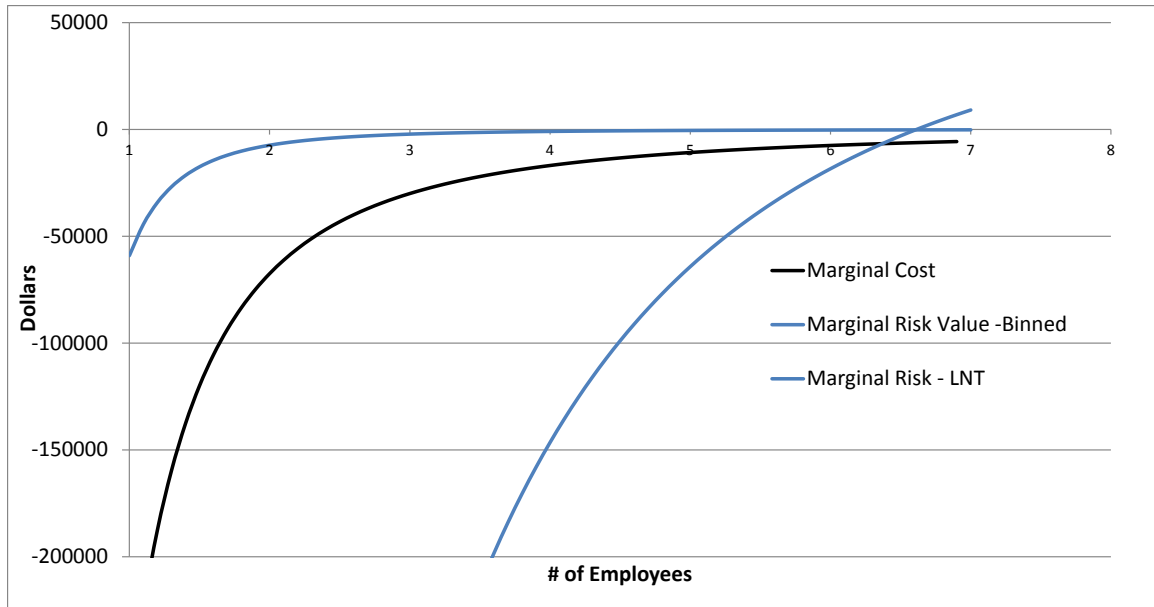

Figure 35. Comparison of marginal risk values for both LNT and bin-averaged estimates of risk with marginal benefit values. Staffing levels are incremented by 0.1 employees.

The marginal benefit represents the change in the amount that the worker will perform as additional workers are added to the project, and thus the change in the effective compensation he will receive for accepting less risk. Based on the estimate of marginal risk value, the point beyond which the marginal risk value increases beyond the marginal benefit is the point at which the employee is being appropriately compensated for the change in risk he is accepting when considering the value of statistical life. At the higher doses (lower number of employees), the change in risk with each individual added to the project decreases the risk value more than it decreases the compensation. Above approximately 6.4 workers, (considering the bin-averaged model) the risk value decreases faster than the compensation; thus the worker is accepting less compensation but not receiving commensurate benefit (in risk reduction). Above around 6.6, for the binned estimates, the hormetic effect comes into play and the worker again begins experiencing some benefit with respect to risk value.

The curve representing the linear, no-threshold estimate of marginal risk value implies that, for all staffing plans, the risk value decreases more slowly than does the worker's compensation for taking on less risk. Thus, when considering this model, there is no reasonable basis for dose spreading beyond local, administrative controls.

Marginal Risk-ALARA Analysis

Because the Department of Energy mandates that doses be kept ALARA, the Los Alamos definition of ALARA-reasonable, (\$2,000 per person rem avoided and \$10,000 per person rem avoided) will be used to calculate the change in the value of ALARA-reasonable expenditures as the staffing levels are increased (and doses to individuals are decreased. This will be compared with the LNT estimate of marginal risk value to estimate at what level the change in risk to the individual equals the change in the Los Alamos definition of reasonable radiation safety expenditures.

The current watch level (at which ALARA-reasonable spending jumps to the \$10,000 per person-rem avoided) is 1 rem. This analysis will consider the marginal ALARA value for this watch level as well as for watch levels set at 0.8 rem/year and 0.5 rem/year. Plots for the comparisons of LNT marginal risk value and marginal ALARA risk value for watch levels set at 1 rem, 0.8 rem, and 0.5 rem are shown in Figure 36, Figure 37, and Figure 38 respectively.

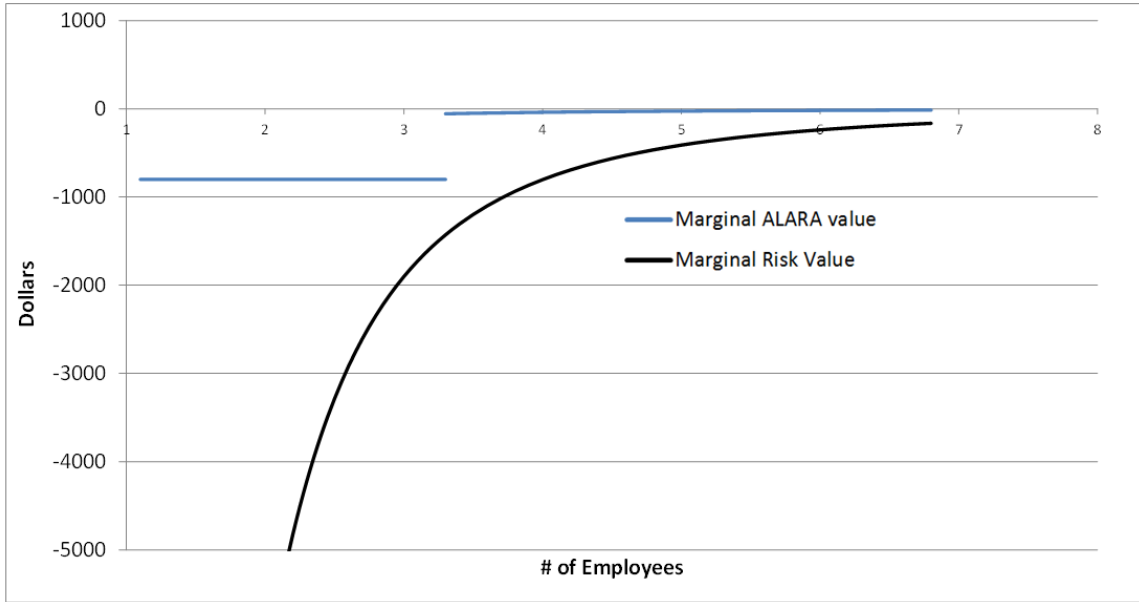

Figure 36. Comparison of Marginal Risk Value (LNT) with marginal ALARA value at a watch level of 1 rem/year. Staff levels are incremented by 0.1 workers. The discontinuity is due to the piece-wise definition of the ALARA value; the break occurs where the first derivative does not exist.

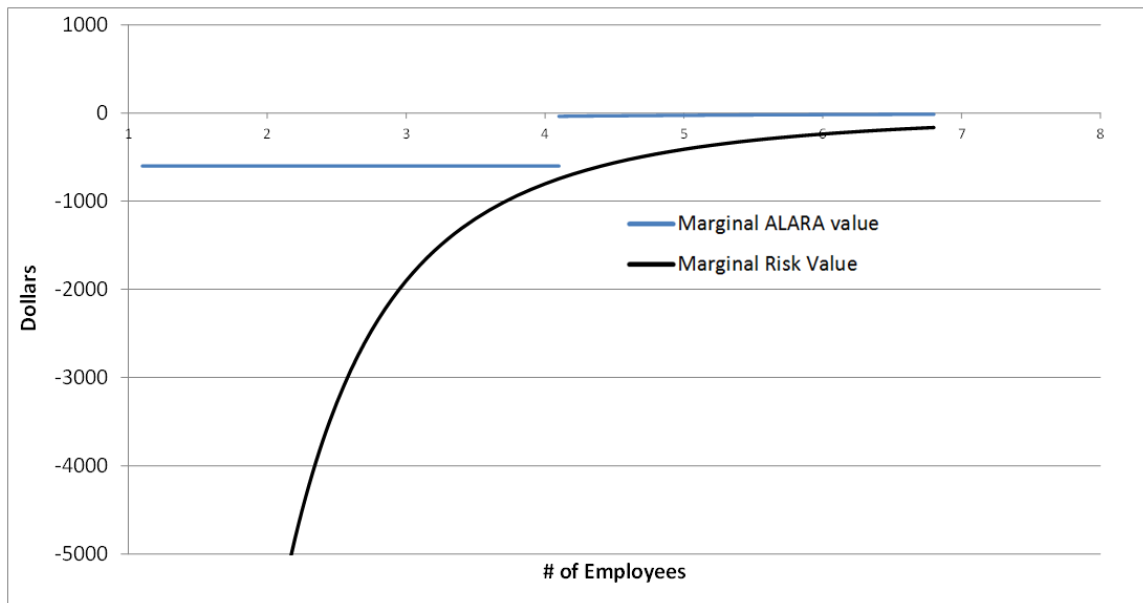

Figure 37. Comparison of Marginal Risk Value (LNT) with marginal ALARA value at a watch level of 0.8 rem/year. Staff levels are incremented by 0.1 workers. The discontinuity is due to the piece-wise definition of the ALARA value; the break occurs where the first derivative does not exist.



Figure 38. Comparison of Marginal Risk Value (LNT) with marginal ALARA value at a watch level of 0.5 rem/year. Staff levels are incremented by 0.1 workers. The discontinuity is due to the piece-wise definition of the ALARA value; the break occurs where the first derivative does not exist.

For watch levels set at 1 and 0.8 rem/year, the change in risk value never reaches the change in ALARA value. This implies that, for these watch levels, the change in spending to reduce the dose to each individual exceeds the reasonable (from the \$2,000/\$10,000 definition) amount that should be spent to achieve the dose reduction affected by each additional employee.

For a watch level of 0.5 rem, the marginal risk value reaches the marginal ALARA value around 5.7 workers (who would each receive around 0.6 rem). This implies that 5.5 workers is, for a watch level of 0.5 rem, the point of diminishing returns; this is to say that beyond a staffing level of about 5.8 workers, the decrease in risk value to each worker will be less than the decrease in spending per worker. Thus it is not cost effective to add additional workers.

When this result is taken along with the risk-benefit analysis illustrated in Figure 35 above, it is seen that selecting a staffing level for this project based on a comparative analysis of the change in cost incurred for a change in risk value (around 6.4 workers) satisfies the ALARA criterion at this watch levels as well as the two less restrictive levels.

3.5 Chapter Conclusions

The work described in this chapter developed a full radiological protection assessment for the developing Americium Recovery Project, including development of exposure cases, creation and modification of MCNP5 models, development of a time-and-motion study and the final synthesis of all data. This work also developed a new method of determining whether administrative controls, such as staffing increases, are ALARA-optimized. This was achieved by the application of risk estimates developed in this work to the doses developed by the dose-assessment to determine the activity-specific risk. The EPA's estimate of the value of statistical life was applied to these risk estimates to determine the risk value. The rate of change of this risk value (marginal risk) was then compared with the rate of change of workers' cost as additional workers were added to the project to reduce the dose (and risk) to each individual.

The dose-modeling effort in this project developed, through interaction with stakeholders and decision makers, a simplified model of the doses expected to be incurred by workers on the ARP at Los Alamos National Laboratory. This was done in two phases: MCNP modeling of relevant exposure cases developed in accordance with the subject-matter expert and the radiation protection division, and estimation of workers

time and motion during each unit operation in the project by interview with the ARP project manager.

The MCNP modeling included both modification of existing glovebox models, and development of new models, especially for extremity dose. The exposure cases were developed over a series of months in weekly meetings with the developer of the ARP and the team leader for radiological engineering at Los Alamos.

3.5.1 Summary of Results

It was found that for 25 operations a year, when also considering the facility background dose, though the whole-body dose to a single employee would not exceed the federal limit of 5 rem/year or the Los Alamos administrative control on extremity dose of 20 rem/year, it would exceed the administrative control limit on whole-body dose as well as the design objectives for both whole-body and extremity dose. Both the radiological and time constraints imposed by the planning basis make multiple workers on the project a necessity.

To estimate the optimal number of workers, risk estimates developed in the previous section were used and applied to the MCNP-calculated doses. These risks were then monetized using the EPA's estimate for the value of statistical life resulting in a quantity called the "risk value." As the dose was spread over a number of workers, the rate of change of the risk value, called the marginal risk value, was compared with the rate of change of the compensation the worker received, called the marginal benefit. The estimate based on this method using a risk value derived from the bin-averaged relative risks estimated that approximately 6.3 workers would be optimum from the perspective of programmatic compensation. Comparing the marginal risk values derived from this

work's LNT estimate of risk to the marginal ALARA value shows that for watch levels of 1 rem/year and 0.8 rem per year, the change in ALARA expenditures per person is always less than the resulting change in risk value per person. This implies that compensating the worker commensurate with their change in risk is within the institutional definition of ALARA-reasonable.

For a watch level of 0.5 rem, however, the change in ALARA expenditures reaches a point of diminishing returns at around 5.5 workers. Thus, for this watch level, it is not cost effective to compensate more than this many workers at the level of their risk value.

The radiological protection organization at Los Alamos is currently investigating methods by which they can quantitatively account for ALARA practices into their analyses. This work presents a method for justifying practices based on the assumed definition of "reasonable." Practices resulting in costs that exceed the "reasonable" threshold, such as dose spreading, though deemed "unreasonable" from an optimization point of view, would be deemed "ultra-reasonable" from an ALARA standpoint.

Chapter 4. Final Summary and Conclusion

4.1 Introduction

This chapter describes the accomplishments and results presented in this research as well as a section suggesting several areas for future work expanding upon that presented here. The work presented in this dissertation spanned several disciplines, including applied and theoretical radiation epidemiology, external dosimetry, and risk assessment. Each section had its own accomplishments and results where an accomplishment describes the development of method or model, and a result is the outcome of the application of the method or model.

4.2 Accomplishments

4.2.1 Epidemiological Accomplishments

This research began by developing a new framework, including a new statistical method, for evaluating the occupational risks seen by workers, not only in radiation environments, but in any setting where ALARA practices are mandated. This was achieved by developing a hypothesis-test-based procedure for evaluating the homogeneity of various epidemiological cohorts, and thus the appropriateness of aggregate data pooling.

When data sets do not conform to an analyst's given criterion for homogeneity, aggregate pooling cannot be applied. Thus, this research developed a new statistical methodology as an alternative to aggregate pooling for situations in which individual cohorts show heterogeneity between them and are thus unsuitable for aggregate analysis. This method was based on fixed- and random-effects models used in statistical meta-analysis for the combination of previously published results.

4.2.2 Accomplishments related to the Americium Recovery Project Analysis

The work described in Chapter 3 developed a full radiological protection assessment for the developing Americium Recovery Project (ARP), including development of exposure cases, creation and modification of MCNP5 models, development of a time-and-motion study, and the final synthesis of all data. This work also developed a new method of determining whether administrative controls, such as staffing increases, are ALARA-optimized. This was achieved by the application of risk estimates developed in this work to the doses developed by the dose-assessment to determine the activity-specific risk. The EPA's estimate of the value of statistical life was applied to these risk estimates to determine the risk value. The rate of change of this risk value (marginal risk) was then compared with the rate of change of burdened, programmatic cost as additional workers were added to the project to reduce the dose (and risk) to each individual.

4.3 Results

4.3.1 Epidemiological Results

The statistical methods that were developed for the analysis of epidemiological data were applied to estimate the all-cancer mortality risks incurred by workers at four Department of Energy nuclear weapons laboratories: Los Alamos National Laboratory, Oak Ridge National Laboratory, the Rocky Flats Plant, and the Hanford Site.

The homogeneity hypothesis-testing procedure developed in this work was applied to these data sets to assess their candidacy for aggregate pooling. It was shown that the unexposed populations from each study were not homogeneous with respect to

each other and thus were not suitable for aggregate pooling. A subset of these studies had been pooled in the past and these studies should be revisited.

Both linear, no-threshold and dose-bin averaged risks were calculated using fixed- and random-effects models (respectively) necessary for combining demonstrably heterogeneous data sets. The linear, no-threshold estimate calculated in this work showed excellent agreement with currently accepted estimates of relative risk per unit dose. The dose-bin averaged risks showed that, for lifetime doses below about 1 rem, exposure to radiation can provide a prophylactic effect with respect to all-cancer mortality. It was further shown that pooled analysis tends to overestimate the risks with respect to those calculated by the methods developed in this work. A reprint of the bin-averaged risks is shown in Figure 39.

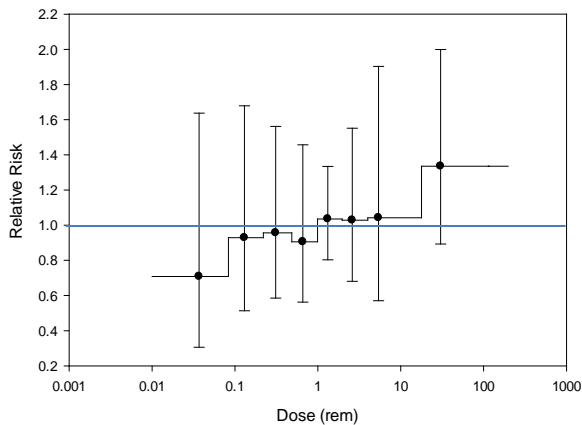

Figure 39. Reprint of dose-bin averaged risks combined using a random-effects model.

4.3.2 Results of the Americium Project Risk Analysis

Dose rates were calculated for each of the selected exposure cases associated with unit operations in the americium recovery project. The primary doses from these processes were found to satisfy the local administrative control limits of 2 rem per year to

the whole body. When considering secondary background doses, the analysis showed that the DOE requirement of 5 rem per year whole body and 50 rem per year to the extremities. A table presenting the calculated whole-body doses for each unit operation is shown in Table 32.

The risk estimates developed in Chapter 2 were used in Chapter 3 to assess the risks to workers engaged in americium recovery operations at Los Alamos. Using the risk-value method of ALARA assessment staffing plans were devised that both satisfied the LANL's administrative control limits and ensured that doses were kept ALARA for several definitions of reasonable.

Table 32. Reprint of photon and neutron contribution to whole-body dose from americium recovery unit operations.

Glovebox	Operation	Photon Contribution		Neutron Contribution	
		Dose per batch (mrem)	Yearly dose (mrem)	Dose per batch (mrem)	Yearly dose (mrem)
Glovebox 1	Primary Pu Processing	15.1	376.6	2.6	64.2
	Glovebox 1 Total	15.1	376.6	2.6	64.2
	Secondary Pu Processing	0.9	21.8	1.1	26.6
Glovebox 2	Am Oxalate Precipitation	7.0	174.2	2.8	69.9
	Glovebox 2 Total	7.8	196	3.86	96.4
	Am Oxalate Calcination	0.3	7.7	1.3	31.7
Glovebox 4	Am Oxide Handling	0.6	15.3	2.9	71.8
	Material Out	3.7	91.6	1.1	28.1
	Glovebox 4 Total	4.6	115	5.26	132
	Sum of all Gloveboxes	27.49	687.19	11.69	292.26

4.4 Future Work

Several areas present themselves for further study. The studies examined in the epidemiological analysis reported doses recorded using differing types of detector (film badges and thermoluminescent dosimeters (TLDs)). The fraction of workers who had doses recorded exclusively in film badges, TLDs and both are shown in Table 33.

Table 33. Fraction of workers from each study with doses recorded by film badge, thermoluminescent dosimeter or both. Estimated based on years of usage for each dosimeter type [126].

Dosimeter Fraction			
	TLD	Film Badge	Both
LANL	0	1	0
Hanford	0.29	0.46	0.25
Rocky	0.32	0.29	0.39
ORNL	0.01	0.91	0.08

The analysis performed in this work would be repeated using datasets that are homogeneous with respect to detector type. Further, the CEDR database contains many additional occupational radiation studies that could be incorporated into the analysis. These additional studies could also be stratified by dosimeter thus allowing the possibility for improved statistical significance despite the reduced cohort sizes. Further the epidemiological methods developed in this work could also be applied to any situation with quantifiably heterogeneous cohorts, not just those exposed to ionizing radiation. One potential radiological case of interest is the analysis of the risks in cohorts exposed to naturally occurring radioactive material (NORM). Geographically disparate cohorts could be combined to make more statistically significant conclusions.

The ALARA staffing methodology developed in this work will be expanded to develop a risk-based estimate for the monetary value of “reasonable” as the \$2,000/\$10,000 definition is obsolescing. This risk-based approach would provide a firmer, more justifiable basis for estimating what constitutes a reasonable standard of safety. New, composite glove materials have been developed and analyzed for this project [127], and their effectiveness in some of the specific exposure cases should be evaluated. Additionally, the dose analysis of the americium recovery project will be compared with actual dosimetry data when the program becomes operational and the differences will be documented.

4.5 Conclusion

This work has developed, from basic epidemiological data, a framework for assessing ALARA practices at specific institutions. By developing institutionally-specific risks in the manner performed in this work (accounting for homogeneity between cohorts and using the new methodology here developed) and applying them to a risk-benefit analysis, it is possible to quantitatively determine whether a given practice is, truly ALARA. Further, the risk-benefit analysis methodology will provide a more rational basis for estimates of ALARA-reasonable values.

Bibliography

- [1] ICRP, "Recommendations of the International Commission on Radiological Protection ICRP Publication 103," *Annals of the ICRP*, vol. 37, 2007.
- [2] S. Russ, "A suggestion for a new X-ray unit in radiotherapy," *Archives of Radiology and Electrotherapy*, vol. 23, pp. 226-232, 1918.
- [3] T. Blum, "Osteomyelitis of the mandible and maxilla. Paper Read before Am. Dental Association, September 1924," *Mon. Labor Rev.*, p. 1222, June 1929.
- [4] J. N. Stannard, *Radioactivity and Health: A History*, Springfield, Va: National Technical Information Service, 1988.
- [5] F. Hoffman, "Radium (Mesothorium) Necrosis," *J. Am. Med. Assoc.*, vol. 85, pp. 961-965, 1925.
- [6] H. Martland, p. Conlon and J. Knep, "Some unrecognized dangers in the use and handling of radioactive substances, with especial reference to the storage of insoluble products of radium and mesothorium in the reticulo-endothelial system," *Journal of the American Medical Association*, vol. 85, pp. 1769-76, 1925.
- [7] G. L. Voelz and I. G. Buican, "Plutonium and Health: How great is the risk?," *Los Alamos Science*, no. 26, pp. 74-89, 2000.
- [8] J. G. Hamilton, "Effects of product on a dog. Monthly health report on problems related to product.," Metallurgical Laboratory Monthly Report CH-2383, Chicago,

II, 1944.

- [9] L. Taylor, "Organization for radiation protection. Operations of the ICRP and NCRP: 1928-1974," Department of Energy, Washington, DC, 1979.
- [10] NCRP, "Permissible Dose from External Sources of Ionizing Radiation, Recommendations of the National Committee on Radiation Protection and Measurement, Report 17," National Committee on Radiation Protection, Handbook 69, National Bureau of Standards, Washington, D.C. , 1954.
- [11] ICRP, "Recommendations of the International Commission on Radiological Protection (As Amended 1959 and Revised 1962), Publication 6," Pergamon Press, Oxford, 1964.
- [12] V. K. Smith and W. H. Desvousges, "An Empirical Analysis of the Economic Value of Risk Changes," vol. 91, no. 1, 1987.
- [13] ICRP, "Recommendations of the International Commission on Radiological Protection, Publication 26, Annals of the ICRP 1, No. 3," Pergamon Press, Oxford, 1977.
- [14] ICRP, "1990 Recommendations of the International Commission on Radiological Protection, Publication 60," Pergamon Press, Oxford, 1991.
- [15] AEA, "Atomic Energy Act of 1954," US Code, Washington DC, 1954.
- [16] R. Faw and J. Shultis, Radiological Assessment: Sources and Doses, La Grange

Park, IL: American Nuclear Society, 1999.

- [17] NCRP, "Recommendations on Limits for Exposure to Ionizing Radiation," National Council on Radiation Protection and Measurements, Bethesda, MD, 1987.
- [18] ICRP, "Recommendations of the International Commission on Radiological Protection, 9 Sep 1958," Pergamon Press, London, 1958.
- [19] D. Watkins, "Radiation Protection," Los Alamos National Laboratory , Los Alamos, NM, 2009.
- [20] J. Cohen, "On Determining the Cost of Radiation Exposure to Populations for Purposes of Cost-Benefit Analyses," *Health Physics*, vol. 25, pp. 527-528, 1973.
- [21] ICRP, "Cost-Benefit Analysis in the Optimization of Radiation Protection," Pergamon Press, Oxford, 1983.
- [22] BEIR, "The Effects on Populations of Exposure to Low Levels of Ionizing Radiation," National Academy of Science, Washington DC, 1972.
- [23] USDHHS, "Centers for Medicare and Medicaid Services," U.S. Department of Health and Human Services, 2009. [Online]. Available: <http://www.cms.gov/Research-Statistics-Data-and-Systems/Statistics-Trends-and-Reports/NationalHealthExpendData/NationalHealthAccountsHistorical.html>. [Accessed 24 3 2014].

- [24] B. Bureau of Labor Statistics, "CPI Inflation Calculator," 2010. [Online]. Available: <http://data.bls.gov/cgi-bin/cpicalc.pl?cost1=200&year1=1972&year2=2010>. [Accessed 4 1 11].
- [25] U. C. Bureau, "The 2012 Statistical Abstract," 27 September 2011. [Online]. Available: [http://www.census.gov/compendia/statab/cats/births_deaths_marriages_divorces/ife_expectancy.html](http://www.census.gov/compendia/statab/cats/births_deaths_marriages_divorces/life_expectancy.html). [Accessed 3 October 2011].
- [26] R. Burk Jr., "Radiation Risk in Perspective," Health Physics Society , 2010.
- [27] NRC, "Health Risks from Exposure to Low Levels of Ionizing Radiation: BEIR VII Phase 2," The National Academy Press, Washington, DC, 2006.
- [28] UNSCEAR, "Summary of low-dose radiation effects on health," United Nations Scientific Committee on the Effects of Atomic Radiation, Vienna, 2010.
- [29] RERF, "Radiation Effects Research Foundation: A cooperative Japan-US REsearch Organization," 10 December 2011. [Online]. Available: http://www.rerf.jp/index_e.html. [Accessed 5 January 2012].
- [30] T. Straume, S. Egbert, W. Woolson, R. Finkel, K. P.W., H. Gove, P. Sharma and M. Hoshi, "Neutron discrepancies in the DS86 Hiroshima dosimetry system," *Health Physics*, vol. 63, pp. 421-426, 1992.
- [31] K. Shizuma, K. Iwatani, H. Hasai, M. HOshi, T. Oka and H. Morishima, "Residual Eu-152 and Co-60 activities induced by neutrons from the Hiroshima atomic

- bomb.," *Health Physics*, vol. 65, pp. 272-282, 1993.
- [32] D. Preston, D. Pierce, Y. Shimizu, H. Cullings, S. Fujita, S. Funamoto and K. Kodama, "Effect of recent changes in atomic bomb survivor dosimetry on cancer mortality risk estimates.," *Radiation Research*, vol. 162, pp. 377-389, 2004.
- [33] C. Li, N. Nishi, J. McDougall, E. Semmens, H. Sugiyama, M. Soda, R. Sakata, M. Hayashi, F. Kasagi, A. Suyama, K. Mabuchi, S. Davis, K. Kodama and K. Kopecky, "Relationship between Radiation Exposure and Risk of Secondary Primary Cancers among Atomic Bomb Survivors," *Cancer Research*, vol. 70, no. 18, pp. 7187-98, 2010.
- [34] D. Preston, Y. Shimizu, D. Pierce, A. Suyama and K. Mabuchi, "Studies of mortality of atomic bomb survivors. Report 13: Solid cancer and noncancer disease mortality: 1950-1997," *Radiation Research*, vol. 160, pp. 381-407, 2003.
- [35] UNSCEAR, "Sources and Effects of Ionizing Radiation. United Nations Scientific Committee on the Effects of Atomic Radiation Report to the General Assembly with Scientific Annexes. Vol II Effects," United Nations, New York, 2000.
- [36] UNSCEAR, "Sources and Effects of Ionizing Radiation. 1993 Report to the General Assembly, with Scientific Annexes.," United Nations, New York, 1993.
- [37] ICRP, "Low-dose Extrapolation of Radiation-related Cancer Risk," Elsevier, 2004.
- [38] D. Brenner, R. Doll, D. Goodhead, E. Hall, C. Land, J. Little, J. Lubin, D. Preston, R. Preston, J. Puskin, E. Ron, R. Sachs, J. Samet, R. Setlov and M. Zaider,

"Cancer risks attributable to low doses of ionizing radiation: Assessing what we really know," *PNAS*, vol. 100, no. 24, pp. 13761-13766, 2003.

- [39] NCRP, "Evaluation of the Linear-Nonthreshold Dose-Response Model for Ionizing Radiation," NCRP, Bethesda, 2001.
- [40] D. Pierce and D. Preston, "Radiation-related cancer risks at low doses among atomic bomb survivors," *Radiation Research*, vol. 154, no. 2, pp. 178-186, 2000.
- [41] ICRP, "Genetic Susceptibility to Cancer," Pergamon, Oxford, 1999.
- [42] D. Bhattacharjee and A. Ito, "Deceleration of carcinogenic potential by adaptation with low-dose gamma irradiation," *In Vivo*, vol. 15, no. 1, pp. 87-92, 2001.
- [43] C. Mothersill and C. Seymore, "Radiation-Induced Bystander Effects: Past History and Future Directions," *Radiation Research*, vol. 155, pp. 757-765, 2001.
- [44] R. D. Evans, "Radium in Man," *Health Physics*, pp. 497-510, 1974.
- [45] D. Pierce, Y. Shimizu, D. Preston, M. Vaeth and K. Mabuchi, "Studies of the mortality of atomic bomb survivors, Report 12, Part I. Cancer," *Radiation Research*, vol. 146, pp. 1-27, 1996.
- [46] M. Tubiana, L. Feinendegen, C. Yang and J. Kaminski, "The Linear No-Threshold Relationship is Inconsistent with Radiation Biologic and Experimental Data," *Radiology*, pp. 13-22, 2007.

- [47] NRC, "Health Effects of Exposure to Low Levels of Ionizing Radiation (BEIR V)," National Academy Press, Washington, DC, 1990.
- [48] A. Upton, "Radiation Hormesis: data and interpretations," *Critical Reviews in toxicology*, vol. 31, pp. 681-695, 2001.
- [49] Y. Xu, C. Greenstock, A. Trivedi and R. Mitchel, "Occupational levels of radiation exposure induce surface expression of interleukin-2 receptors in stimulated peripheral blood lymphocytes," *Environmental Biophysics*, vol. 35, pp. 89-93, 1996.
- [50] M. Pollycove and L. Feinendegen, "Molecular biology, epidemiology and the demise of the linear no-threshold hypothesis," *C.R. of the Academy of Sciences*, vol. 322, pp. 197-204, 1999.
- [51] C. Mothersill and C. Seymore, "Radiation-induced bystander effects and the DNA paradigm: an "out of field" perspective.," *Mutation Research*, vol. 597, pp. 5-10, 2006.
- [52] G. Schettino, M. Folkard, B. Michael and K. Prise, "Low-dose binary behavior of bystander cell killing after microbeam irradiation of a single cell with focused c(k) x rays," *Radiation Research*, vol. 163, no. 3, pp. 332-336, 2005.
- [53] E. Gilbert, S. Fry, L. Wiggs, G. Voelz, D. Cragle and G. Petersen, "Methods for Analyzing Combined Data from Studies of Workers Exposed to Low Doses of Radiation," *American Journal of Epidemiology*, vol. 131, pp. 917-927, 1990.

- [54] E. Gilbert, D. Cragle and L. Wiggs, "Updated Analyses of combined Mortality Data on Workers at the Hanford Site, Oak Ridge National Laboratory, and Rocky Flats Weapons Plant," *Radiation Research*, vol. 136, pp. 408-421, 1993.
- [55] J. Abbat, T. Hamilton and J. Weeks, "Epidemiological studies in three corporations covering the Canadian nuclear fuel cycle.," International Atomic Energy Agency, Vienna, 1983.
- [56] L. Craig and H. Seidman, "Leukemia and lymphoma mortality in relation to cosmic radiation," *Blood*, vol. 17, p. 319, 1961.
- [57] N. Frigerio and R. Stow, "Carcinogenic and genetic hazard from background radiation," in *IAEA Symposium on the Biological and Environmental Effects of Low-Level Radiation*, vol. 2, Vienna, 1976.
- [58] K. Nambi and S. Soman, "Further observations on environmental radiation and cancer in India," *Health Physics*, vol. 59, no. 3, pp. 339-344, 1990.
- [59] R. Haynes, "The distribution of domestic radon concentrations and lung cancer mortality in England and Wales," *Radiation Protection Dosimetry*, vol. 25, no. 2, pp. 93-96, 1988.
- [60] B. Cohen, "Test of the linear-no threshold theory of radiation carcinogenesis for inhaled radon decay products," *Health Physics*, vol. 68, no. 2, pp. 157-174, 1995.
- [61] R. Sachs, P. Hahnfeld and D. Brenner, "The link between low-LET dose-response relations and the underlying kinetics of damage production/repair/misrepair,"

International Journal of Radiation Biology, vol. 72, no. 4, pp. 351-374, 1997.

- [62] DOE, "Facility design and modifications," US Department of Energy, Washington, DC, 2011.
- [63] S. R. Weart, *Scientists in Power*, Cambridge : Harvard University Press, 1979.
- [64] T. E. Widner, "Technical Basis Document for the Los Alamos National Laboratory - Occupational External Dose," ORAU, 2005.
- [65] R. Andrews, *Managing the Environment, Managing Ourselves*, New Haven: Yale University Press, 2006.
- [66] B. Stokes, "ALARA Program Protects Workers and the Public," *Actinide Research Quarterly*, 1998.
- [67] K. Roark, "News Releases," 9 July 2004. [Online]. Available: <http://www.lanl.gov/news/releases/archive/04-066.shtml>. [Accessed 23 May 2011].
- [68] G. P. Nanos, *Suspension of All Activities*, 2004.
- [69] K. DeLucas, "News Releases," 12 October 2004. [Online]. Available: <http://www.lanl.gov/news/releases/archive/04-082.shtml>. [Accessed 23 May 2011].
- [70] C. A. Clark, "Security stops gold theft at lab," *Los Alamos Monitor*, p. 2009, 31

March 2009.

- [71] M. e. a. Vrijheid, "The 15-Country Collaborative Study of Cancer Risk among Radiation Workers in the Nuclear Industry: Design, Epidemiological Methods and Descriptive Results," *Radiation Research*, vol. 167, pp. 361-379, 2007.
- [72] E. Cardis and e. al., "The 15-Country Collaborative Study of Cancer Risk among Radiation Workers in the Nuclear Industry: Estimates of Radiation-Related Cancer Risks," *Radiation Research*, vol. 167, pp. 396-416, 2007.
- [73] J. Acquavella and G. Wilkinson, "The National Plutonium Workers Study Considerations and Preliminary Results," Los Alamos National Laboratory, Los Alamos, NM, 1983.
- [74] G. Tietjen, "Plutonium and Lung Cancer," *Health Physics*, vol. 52, pp. 625-628, 1987.
- [75] G. Wilkinson, J. Acquavella, G. Voelz, G. Tietjen and C. Key, "Cancer Incidence and Mortality Among Plutonium and Other Radiation Workers," in *Proceedings of the International Symposium on the Biological Effects of Low-Level Radiation with the Special Regard to Stochastic and Non-Stochastic Effects*, International Atomic Energy Agency and the World Health Organization, 1983.
- [76] G. Voelz, G. Wilkinson, J. F. Acquavella, M. Reyes and J. McInroy, "A Review of Epidemiologic Studies at Los Alamos National Laboratory," *Proceedings of the DOE Radiation Epidemiology Contractors Workshop*, 1982.

- [77] J. Acquavella, G. W. L. Wilkinson, G. Tietjen and C. Key, "An Evaluation of Cancer Incidence Among Employees at the Los Alamos National Laboratory," in *Proceedings of the 16th Mid-Year Topical Meetings; Epidemiology Applied to Health Physics*, Albuquerque, NM, 1983.
- [78] G. W. G. Voelz, J. Healy, J. McInroy and G. Tietjen, "Mortality Study of Los Alamos Workers with Higher Exposures to Plutonium," in *Proceedings of the 16th Mid-Year topical Meeting; Epidemiology Applied to Health Physics*, Albuquerque, NM, 1983.
- [79] L. Wiggs, "Mortality Among Females Employed by the Los Alamos National Laboratory," University of Oklahoma, 1987.
- [80] L. Hempelmann, W. Langham, C. Richmond and G. L. Voelz, "Manhattan Project Plutonium Workers: A Twenty-Seven Year Study of Selected Cases," *Health Physics*, vol. 24, pp. 461-479, 1973.
- [81] G. Voelz, L. Hempelmann, J. Lawrence and W. Moss, "A 32-Year Medical Follow-up of Manhattan Project Plutonium Workers," *Health Physics*, vol. 37, pp. 445-485, 1979.
- [82] G. Voelz, R. Grier and L. Hempelmann, "A 37-Year Medical Follow-up of Manhattan Project Plutonium Workers," *Health Physics*, vol. 48, pp. 249-259, 1985.
- [83] G. Voelz and J. Lawrence, "A 42-Year Follow-up of Manhattan Project Plutonium

Workers," *Health Physics*, vol. 61, pp. 181-190, 1991.

- [84] G. Voelz, J. Lawrence and E. Johnson, "Fifty Years of Plutonium Exposure to the Manhattan Project Plutonium Workers, An Update," *Health Physics*, vol. 73, pp. 611-619, 1997.
- [85] E. Gilbert, S. Fry, L. Wiggs, G. Voelz, D. Cragle and G. Petersen, "Analyses of Combined Mortality Data on Workers at the Hanford Site, Oak ridge National Laboratory and Rocky Flats Nuclear Weapons Plant," *Radiation Research*, vol. 120, pp. 19-35, 1989.
- [86] E. Gilbert, "Issues in Analysing the Effects of Occupational Exposure to Low Levels of Radiation," *Statistics in Medicine*, vol. 8, pp. 173-187, 1989.
- [87] A. Whitehead and J. Whitehead, "A general parametric approach to the meta-analysis of randomaized clinical trials," *Statistics in Medicine*, vol. 10, no. 11, pp. 1665-1677, 1991.
- [88] ORISE, "Comprehensive Epidemiologic Data Resource," Oak Ridge Institute for Science and Education, January 2104. [Online]. Available: <https://www3.ornl.gov>. [Accessed 14 January 2014].
- [89] V. Beral, L. Carpenter, M. Booth, H. Inskip and A. Brown, "The 'healthy worker' effect and other determinants of mortality in workers in the nuclear industry," British Nuclear Energy Society , London, 1988.

- [90] BEIR, "Health Risks from Exposure to Low Levels of Ionizing Radiation: BEIR VII Phase 2," The National Academies Press, Washington, DC, 2006.
- [91] RERF, "Radiation Effects Research Foundation: A cooperative Japan-US Research Organization," 10 December 2011. [Online]. Available: http://www.rerf.jp/index_e.html. [Accessed 5 January 2012].
- [92] G. Casella and R. L. Berger, Statistical Inference, Pacific Grove, CA: Duxbury, 2002.
- [93] K. Rothman, Modern Epidemiology, Boston: Little, Brown and Company, 1986.
- [94] J. Lubin and J. Boice Jr., "Lung Cancer Risk from Residential Radon: Meta-analysis of Eight Epidemiologic studies," *Journal of the National Cancer Institute*, vol. 89, no. 1, pp. 49-57, 1997.
- [95] B. Caffo, "Methods in Biostatistics II," 19 December 2007. [Online]. Available: <http://ocw.jhsph.edu/courses/methodsinbiostatisticsii/PDFs/lecture18.pdf>. [Accessed 17 February 2014].
- [96] L. Hedges and I. Olkin, Statistical Methods for Meta-Analysis, Orlando, FL: Academic Press, Inc., 1985, pp. 110-111.
- [97] J. L. Fleiss, "The statistical basis of meta-analysis.," *Statistical Methods in Medical Research*, vol. 2, pp. 121-145, 1993.
- [98] G. Voelz, "Analytic Health Study of Los Alamos, Zia Company and Manhattan

Project Workers, 1994," 1993-1994. [Online]. Available:

https://www.ornl.gov/cedr/search_results.aspx?DataSet=LAHWA04%20&Value=Analytic%20Health%20Study%20of%20Los%20Alamos,%20Zia%20Company,%20and%20Manhattan%20Project%20Workers,%201994%20&MultiName=Los%20Alamos. [Accessed 30 August 2011].

[99] L. Wiggs, "Rocky Flats Analytic Study, 1993," August 1993. [Online]. Available:

https://www.ornl.gov/cedr/search_results.aspx?DataSet=RFANLA02%20&Value=Rocky%20Flats%20Analytic%20Study,%201993%20&MultiName=Rocky%20Flats. [Accessed 30 August 2011].

[100] S. Wing, "Hanford Workers Cohort Study Follow-up through 1994," 1994.

[Online]. Available:

https://www.ornl.gov/cedr/search_results.aspx?DataSet=HFWC94A1%20&Value=Hanford%20Workers%20Cohort%20Study%20Follow-up%20Through%201994%20&MultiName=Hanford. [Accessed 30 August 2011].

[101] E. Frome, D. Cragle, J. Watkins, S. Wing, S. Shy, W. Tankersley and C. West, "A

Mortality Study of Employees of the Nuclear Industry in Oakridge Tennessee,"

Radiation Research, vol. 148, pp. 64-80, 1997.

[102] D. Kelly, Introduction to Statistical Theory: Course Notes for STOR 555, Fall

2008, Chapel Hill: University of North Carolina, 2008.

[103] E. S. Gilbert, D. Cragle and L. Wiggs, "Updated Analysis of Combined Mortality

Data for Workers at the Hanford Site, Oak Ridge National Laboratory and Rocky

Flats Weapons Plant," *Radiation Research*, vol. 136, pp. 408-421, 1993.

- [104] J. D. ROBERTSON, "Historical Exposures to Chemicals at the Rocky Flats Nuclear Weapons Plant: A Pilot Retrospective Exposure Assessment," Los Alamos National Laboratory, Los Alamos, NM, 1998.
- [105] D. o. Energy, "THE DEPARTMENT OF ENERGY'S ROCKY FLATS PLANT: A GUIDE TO RECORD SERIES USEFUL FOR HEALTH-RELATED RESEARCH VOLUME VII. EMPLOYEE OCCUPATIONAL EXPOSURE AND HEALTH," Department of Energy, [Online]. Available: <http://www.hss.doe.gov/healthsafety/ohre/new/findingaids/epidemiologic/rockyplant/employ/intro.html>. [Accessed 22 May 2013].
- [106] G. D. Kerr, E. L. Frome, J. P. Watkins and W. G. Tankersly, "Historical Evaluation of the Film Badge Dosimetry Program at the Y-12 Plant in Oak Ridge, Tennessee: Part 2- Neutron Radiation," Oak Ridge Associated Universities, Oak Ridge, 2009.
- [107] A. Dean, K. Sullivan and M. Soe, "OpenEpi: Open Source Epidemiologic Statistics for Public Health, Version.," 6 April 2013. [Online]. Available: www.OpenEpi.com. [Accessed 02 April 2014].
- [108] T. J. Vigil and D. E. Kornreich, "Alternatives Analysis for Americium-241 recovery operations," Los Alamos National Laboratory, Los Alamos, 2010.
- [109] D. Kornreich, L. Schulte and T. Vigil, "System Functions and Requirements

Analysis for Am-241 Recovery Operations," Los Alamos National Laboratory,
Los Alamos, NM, 2010.

- [110] D. Kornreich, M. Burnside, R. Burnside, N. Demuth, J. Gonzales-Lujan, B. Hadden, K. Lier, J. Jackson, R. Parker and T. Rising, "TA-55 Pit Manufacturing Responsive Infrastructure and Capacity Study (U)," Los Alamos National Laboratory, Los Alamos, 2005.
- [111] DOE, "Title 10 of the Code of Federal Regulations Part 835 Section 202. Occupational Dose Limits for General Employees," Washington DC, 2004.
- [112] A. Crawford, *MCNP Geometry model for CLEAR line Americium Glove boxes*, LANL Internal Document, 2009.
- [113] R. B. O. Olsher and A. Davis, *CLEAR LINE: GB2 - Am Extraction Chromatography and Precipitation: based on GB1 model by Art Crawford.*, Los Alamos National Laboratory, 2012.
- [114] D. Gonzalez and A. Davis, *CL Furnace GB*, Los Alamos, 2012.
- [115] S. Apgar, "Americium-241 Oxide Inner Container," Los Alamos National Laboratory, Los Alamos, 2012.
- [116] S. Apgar, "Inner and Outer Holding Jig," Los Alamos National Laboratory, Los Alamos, 2013.
- [117] S. Apgar, "Americium-241 Oxide Middle Container," Los Alamos National

Laboratory, Los Alamos, 2012.

- [118] ICRP, "Conversion Coefficients for use in Radiological Protection Against External Radiation," Pergamon, 1996.
- [119] R. M. Barnes, *Motion and Time Study*, New York: John Wiley and Sons, Inc., 1940.
- [120] L. D. Schulte, Interviewee, *Personal Communication*. [Interview]. 3/13/14.
- [121] E. Kunz and I. Bucina, "Some problems in practical application of the dose limitation system," in *Proceedings of a topical seminar on the practical implications of the ICRP recommendations (1977) and the revised IAEA basic standards for radiation protection. Applications of the Dose Limitation System for Radiation Protection*. , Vienna, 1979.
- [122] EPA, "National Center for Environmental Economics," 13 3 2014. [Online]. Available:
<http://yosemite.epa.gov/ee/epa/eed.nsf/pages/MortalityRiskValuation.html>. [Accessed 2011 2 6].
- [123] BLS, "Bureau of Labor Statistics: CPI Inflation Calculator," May 2014. [Online]. Available: http://www.bls.gov/data/inflation_calculator.htm. [Accessed 2014 March 13].
- [124] U. E. P. Agency, "Valuing Mortality Risk Reductions for Environmental Policy: A White Paper (Draft)," U.S. Environmental Protection Agency, National Center for

Environmental Economics, 2010.

[125] L. Schulte, 2011.

[126] O. R. A. Universities, "Dosimeters," Oak Ridge Associated Universities, 20 April 10. [Online]. Available:
<http://www.ornl.gov/ptp/collection/dosimeters/dosimeters.htm>. [Accessed 22 May 2013].

[127] A. Davis and D. J. Dudziak, "A new analysis of composite materials for use in glove-box applications," *Nuclear Technology*, vol. 180, pp. 139-148, 2011.

[128] F. H. Attix, *Introduction to Radiological Physics and Radiation Dosimetry*, Weinheim: Wiley-VCH, 2004.